



**NOKIA
3660**

**Extended User's
Guide**

CE 168

DECLARATION OF CONFORMITY

We, NOKIA CORPORATION declare under our sole responsibility that the product NHL-8 is in conformity with the provisions of the following Council Directive: 1999/5/EC. A copy of the Declaration of Conformity can be found from http://www.nokia.com/phones/declaration_of_conformity/

Copyright © 2003 Nokia. All rights reserved.

Reproduction, transfer, distribution or storage of part or all of the contents in this document in any form without the prior written permission of Nokia is prohibited. Nokia, Nokia Connecting People and Xpress-on are registered trademarks of Nokia Corporation. Other product and company names mentioned herein may be trademarks or tradenames of their respective owners.

Nokia tune is a sound mark of Nokia Corporation.

This product includes software licensed from Symbian Ltd © 1998-2002

© 1998-2002 Symbian Ltd. All rights reserved. Symbian and Symbian OS are trademarks of Symbian Ltd. All rights reserved.



Java™ and all Java-based marks are trademarks or registered trademarks of Sun Microsystems, Inc.

USE OF THIS PRODUCT IN ANY MANNER THAT COMPLIES WITH THE MPEG-4 VISUAL STANDARD IS PROHIBITED, EXCEPT FOR USE DIRECTLY RELATED TO (A) DATA OR INFORMATION (i) GENERATED BY AND OBTAINED WITHOUT CHARGE FROM A CONSUMER NOT THEREBY ENGAGED IN A BUSINESS ENTERPRISE, AND (ii) FOR PERSONAL USE ONLY; AND (B) OTHER USES SPECIFICALLY AND SEPARATELY LICENSED BY MPEG LA, L.L.C.

Stac®, LZS®, ©1996, Stac, Inc., ©1994-1996 Microsoft Corporation. Includes one or more U.S. Patents: No. 4701745, 5016009, 5126739, 5146221, and 5414425. Other patents pending.

Hi/fn®, LZS®, ©1988-98, Hi/fn. Includes one or more U.S. Patents: No. 4701745, 5016009, 5126739, 5146221, and 5414425. Other patents pending.

Part of the software in this product is © Copyright ANT Ltd. 1998. All rights reserved.

m-Router Connectivity Components © 2000-2002 Intuwave Limited. All rights reserved. (www.intuwave.com)

US Patent No 5818437 and other pending patents. T9 text input software Copyright (C) 1997-2003. Tegic Communications, Inc. All rights reserved.

Nokia operates a policy of continuous development. Nokia reserves the right to make changes and improvements to any of the products described in this document without prior notice.

Under no circumstances shall Nokia be responsible for any loss of data or income or any special, incidental, consequential or indirect damages howsoever caused.

The contents of this document are provided 'as is'. Except as required by applicable law, no warranties of any kind, either express or implied, including, but not limited to, the implied warranties of merchantability and fitness for a particular purpose, are made in relation to the accuracy, reliability or contents of this document. Nokia reserves the right to revise this document or withdraw it at any time without prior notice

The availability of particular products may vary by region. Please check with the Nokia dealer nearest to you.

9362394

Issue 2 EN

Copyright © 2003 Nokia. All rights reserved.

Contents

For your safety	6	Call barring (network service).....	43
General information	8	Network.....	43
Standby mode	8	Accessory settings.....	44
Menu	10	Contacts	45
Options lists.....	12	Creating contact cards.....	45
Online help.....	12	Copying contacts between the SIM card and phone memory.....	45
Navigation bar – moving horizontally.....	13	Editing contact cards.....	46
Actions common to all applications.....	13	Viewing a contact card.....	47
Volume control.....	14	Managing contact groups.....	51
Shared memory.....	16	Camera and Images	53
Your phone	17	Taking pictures.....	53
Making a call.....	17	Images – Storing pictures.....	57
Answering a call.....	19	Video recorder	61
Log – Call register and general log	21	Recording a video clip.....	61
SIM folder	26	Watching a video clip.....	62
Settings	27	Sending video clips	62
Changing general settings	27	Setting up your Video recorder.....	62
Phone settings	27	RealOne Player™	63
Call settings.....	29	Media Guide.....	64
Connection settings.....	31	Playing media files.....	64
Date and time	38	Sending media files.....	66
Security.....	38		

Changing the settings.....	67
Messaging	68
Messaging - General information	69
Writing text	71
Creating and sending new messages.....	74
Inbox - receiving messages.....	81
My folders	85
Remote mailbox.....	85
Outbox.....	91
Viewing messages on a SIM card.....	91
Cell broadcast (network service).....	91
Service command editor.....	92
Messaging settings.....	92
Profiles.....	99
Changing the profile	99
Customising profiles.....	99
Favourites.....	101
Adding shortcuts	101
Calendar and To-do.....	102
Creating calendar entries.....	102
Setting calendar alarms	105
To-do.....	106
Importing data from other Nokia phones	107
Extras.....	108

Calculator.....	108
Composer.....	109
Converter.....	110
Notes	112
Clock.....	112
Recorder.....	113
Games.....	113
Memory card	114

Services (XHTML)

Services (XHTML)	117
Basic steps for accessing	117
Setting up the phone for the browser service.....	118
Making a connection	118
Connection security	119
Viewing bookmarks	119
Browsing.....	120
Viewing saved pages.....	121
Downloading	122
Ending a connection	123
Browser settings.....	123

Applications (Java™)

Applications (Java™)	125
Installing a Java application.....	126
Java application settings	127

Manager - installing applications and software

Manager - installing applications and software	128
Installing software.....	129

Removing software	130
Viewing memory consumption	130

Connectivity 131

Bluetooth connection.....	131
Infrared connection.....	136
Connecting your phone to a computer	138
Sync - remote synchronisation.....	138

Troubleshooting 141

Q&A.....	142
----------	-----

Battery information..... 145

Care and maintenance 146

Important safety information 147

Index 151

For your safety

Read these simple guidelines. Breaking the rules may be dangerous or illegal. Further detailed information is given in this manual.

! Please refer to the **Quick start guide of the product for instructions on operation, care and maintenance, including important safety information.**



Do not switch the phone on when wireless phone use is prohibited or when it may cause interference or danger.



ROAD SAFETY COMES FIRST Don't use a hand-held phone while driving.



INTERFERENCE All wireless phones may get interference, which could affect performance.



SWITCH OFF IN HOSPITALS Follow any regulations or rules. Switch the phone off near medical equipment.



SWITCH OFF IN AIRCRAFT Wireless devices can cause interference in aircraft.



SWITCH OFF WHEN REFUELLING Don't use the phone at a refuelling point. Don't use near fuel or chemicals.



SWITCH OFF NEAR BLASTING Don't use the phone where blasting is in progress. Observe restrictions, and follow any regulations or rules.



USE SENSIBLY Use only in the normal position. Don't touch the antenna unnecessarily.



QUALIFIED SERVICE Only qualified personnel may install or repair phone equipment.



ACCESSORIES AND BATTERIES Use only approved accessories and batteries. Do not connect incompatible products.



WATER-RESISTANCE Your phone is not water-resistant. Keep it dry.





BACKUP COPIES Remember to make backup copies of all important data.





CONNECTING TO OTHER DEVICES When connecting to any other device, read its user's guide for detailed safety instructions. Do not connect incompatible products.



CALLING Ensure the phone is switched on and in service. Enter the phone number, including

the area code, then press . To end a call, press . To answer a call, press .



EMERGENCY CALLS Ensure the phone is switched on and in service. Press  as many times as needed (e.g. to exit a call, to exit a menu, etc.) to clear the display. Enter the emergency number, then press . Give your location. Do not end the call until told to do so.

Network Services

The wireless phone described in this guide is approved for use on the EGSM 900 and GSM 1800 and 1900 networks.

A number of features included in this guide are called Network Services. These are special services that you arrange through your wireless service provider. Before you can take advantage of any of these Network Services, you must subscribe to them through your service provider and obtain instructions for their use from your service provider.

 **Note:** Some networks may not support all language-dependent characters and/or services.

Chargers and accessories

 **Note:** Check the model number of any charger before use with this device. This device is intended for use when supplied with power from ACP-8, ACP-12, LCH-9 and LCH-12.

 **WARNING!** Use only batteries, chargers and accessories approved by the phone manufacturer for use with this particular phone model. The use of any other types may invalidate any approval or warranty applying to the phone, and may be dangerous.

For availability of approved accessories, please check with your dealer.

When you disconnect the power cord of any accessory, grasp and pull the plug, not the cord.

When using the features in this device, obey all laws and honor privacy and legitimate rights of others.

1. General information

Nokia 3660 provides various functions, which are very handy for daily use, such as Camera, Video recorder, Messaging, e-mail, Clock, alarm clock, Calculator, and Calendar.

Stickers in the sales package

- The stickers included in the sales package contain important information for service and customer support purposes. The sales package also includes instructions on how you should use these stickers.

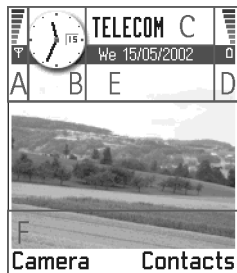





Fig. 1 Standby mode with a background image.

Standby mode

The indicators described below are shown when the phone is ready for use, with no characters keyed in. In this state, the phone is in 'standby mode'. In Fig. 1:

- A** Shows the signal strength of the cellular network at your current location. The higher the bar, the stronger the signal. The antenna symbol is replaced with the GPRS symbol  when *GPRS connection* has been set to *When available* and a connection is available in the network or in the current cell. See '[Packet data \(General Packet Radio Service, GPRS\)](#)', p. [32](#) and '[GPRS](#)', p. [37](#).
- B** Shows an analogue or a digital clock. See also settings for '[Date and time](#)', p. [38](#) and settings for Standby mode → Background image, p. [28](#).
- C** Indicates in which cellular network the phone is currently being used.
- D** Shows the battery charge level. The higher the bar, the more power left in the battery.
- E** Navigation bar: shows the currently active profile. If the selected profile is *General*, the current date is displayed instead of the profile name. For further information, see '[Navigation bar - moving horizontally](#)', p. [13](#) and '[Profiles](#)', p. [99](#).

F Shows the current shortcuts assigned for the selection keys  and .



Note: Your phone has a screen saver. If there are no actions for five minutes, the display is cleared and a screen saver becomes visible. See p. [29](#). To deactivate the screen saver, press any key.



Tip! You can change the selection key shortcuts and the background image. See the settings for '[Standby mode](#)', p. [28](#).

Indicators related to actions

One or more of the following icons may be shown when the phone is in standby mode:



- Indicates that you have received new messages to the Inbox in Messaging. If the indicator is blinking, the phone memory is low and you must delete some data. For further information, see '[Memory low](#)', p. [141](#).



- Indicates that you have received new e-mail.



- Indicates that you have received one or several voice messages. See '[Calling your voice mailbox](#)', p. [18](#).



- Indicates that there are messages waiting to be sent in Outbox. See p. [69](#).



- Shown when *Incoming call alert* has been set to *Silent* and *Message alert tone* to *Off* in the currently active profile. See '[Profiles](#)', p. [99](#).



- Indicates that the phone's keypad is locked. See the Quick start guide.



- Indicates that you have an active alarm. See '[Clock](#)', p. [112](#).



- Indicates that Bluetooth is active. Note that, when data is transmitted via Bluetooth,  is shown.





- Indicates that all calls to the phone are diverted.  - Indicates that all calls to the phone are diverted to a voice mailbox. See '[Settings for call diverting](#)', p. [21](#). If you have two phone lines, the divert indicator for the first line is  and for the second line . See '[line in use \(network service\)](#)', p. [30](#).



Fig. 2 The main Menu.

Options in the Menu:

Open, List view / Grid view, Delete, Move, Move to folder, New folder, Rename, Help, and Exit.

2 - Indicates that you can make calls using phone line 2 only (network service). See '[Line in use \(network service\)](#)', p. 30.

Data connection indicators

- When an application is establishing a data connection, one of the indicators below blinks in standby mode.
- When an indicator is shown continuously, the connection is active.

D for a data call, **D*** for a high speed data call,

G is shown instead of the antenna symbol when there is an active GPRS connection. **G** for when the GPRS connection is put on hold during voice calls.

F for a fax call,

(B) for a Bluetooth connection, and

IR for an infrared connection.



- Press **(M)** (Menu key) to open the main Menu. In the Menu, you can access all the applications in your phone. See Fig. 2, p. 10.

Moving in the Menu

- Press the scroll key on the top **(1)**, bottom **(2)**, left **(3)** and right **(4)** (shown with blue arrows 1 to 4 in Fig. 3, p. 11) to move in the Menu.



Opening applications or folders

- Scroll to an application or a folder and press the scroll key in the middle **(5)** (shown with blue arrow 5 in Fig. 3, p. 11) to open it.

Closing applications

- Backstep by pressing **Back** as many times as is needed to return to standby mode or select **Options**→ *Exit*.

If you press and hold , the phone returns to standby mode and the application is left open in the background.

 **Note:** Pressing  will always end a call, even if another application is active and displayed on the display.

When you switch the phone off, applications are closed and any unsaved data is saved automatically.

Rearranging the Menu

You can rearrange the Menu in any order you like. You can place more rarely used applications in folders and move applications that you use more often from a folder to the Menu. You can also create new folders.

- 1 Scroll to the item you want to move and select **Options**→ *Move*. A check mark is placed beside the application.
- 2 Move the selection where you want the application to be and press **OK**.

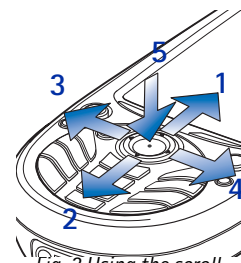

Fig. 3 Using the scroll key to move.



Tip! Select **Options**→ *List view* if you want to view the applications in a list.

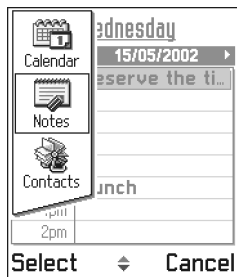



Fig. 4 Application switching window

Options

Switching between applications

If you have several applications open and want to switch from one application to another: Press and hold  (Menu key). The application switching window opens showing a list of applications that are currently open. See Fig. 4, p. 12. Scroll to an application and press  to go to it.



Note: If memory is getting low, the phone may close some applications. The phone saves any unsaved data before an application is closed.

Options lists

In this User's Guide, you can see the Options list commands listed on the side of the page. These lists tell you which commands are available in different views and situations.



Note: The available commands change depending on the view you are in.



Tip! In some situations, when you press the scroll key, a shorter options list appears listing the main commands available in the view.

Online help





Your Nokia 3660 has a help function that you can access from any application which has the [Options](#) selection, and can be accessed using the  key. See Fig. 5, p. 13.

Navigation bar – moving horizontally

In the navigation bar, you can see:

- small arrows or tabs which tell you if there are more views, folders, or files you can move to. See Fig. 6, p. 13.
- editing indicators, see ['Writing text'](#), p. 71.
- other information, for example, in Fig. 6., 2/14 means that the current picture is the second of 14 pictures in the folder. Press  to see the next picture.

Actions common to all applications

- **Opening items for viewing** – When you are viewing a list of files or folders, to open an item, scroll to an item and press the scroll key or select **Options**→ *Open*.
- **Editing items** – To open an item for editing, you sometimes need to first open it for viewing and then select **Options**→ *Edit*, if you want to change its contents.
- **Renaming items** – To give a new name to a file or folder, scroll to it and select **Options**→ *Rename*.
- **Removing, deleting items** – Scroll to the item and select **Options**→ *Delete* or press . To delete many items at a time, you first need to mark them. See the next paragraph: 'Marking an item'.
- **Marking an item** – There are several ways to select items when you are in a list.
 - To select one item at a time, scroll to it and select **Options**→ *Mark/Unmark*→ *Mark* or press  and the scroll key at the same time. A check mark is placed next to the item.
 - To select all items in the list, select **Options**→ *Mark/Unmark*→ *Mark all*.
- **Marking multiple items** – Press and hold  and at the same time move the scroll key down or up. As the selection moves, a check mark is placed next to the items. To end the selection, stop the scrolling with the scroll key and then release . After you have selected all the items you want, you can move or delete them by selecting **Options**→ *Move to folder* or *Delete*.

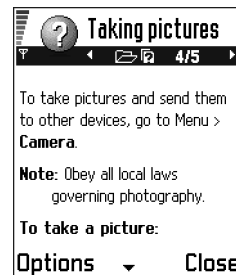

Fig. 5 Online help topic.



Fig. 6 Arrows and tabs on the navigation bar.



Tip! For information on how to insert text and numbers, see ['Writing text'](#), p. 71.



Fig. 7 Search field in Contacts

- To unmark an item, scroll to it and select **Options**→ *Mark/Unmark*→ *Unmark* or press  and the scroll key at the same time.
- **Creating folders** - To create a new folder, select **Options**→ *New folder*. You are asked to give a name to the folder (max. 35 letters).
- **Moving items to a folder** - To move items to a folder or between folders, select **Options**→ *Move to folder* (not shown if there are no folders available). When you select *Move to folder*, a list of available folders opens and you can also see the root level of the application (for moving an item out of a folder). Select the location you want the item to be moved to and press **OK**.





Searching for items

You can search for a name, file, folder, or shortcut by using the search field. In some situations the search field is not visible automatically, and you can activate it by selecting **Options**→ *Find* or just by starting to key in letters.

- 1 To search for an item, start to key in text in the search field. The phone immediately starts to search for matches and moves the selection on the best match. See Fig. [Z](#), p. [14](#).
To make the search more accurate, key in more letters and the selection moves to the item that best matches the letters.
- 2 When the correct item is found, press  to open it.

Volume control

- When you have an active call or are listening to a sound, press  or  to increase or decrease the volume level, respectively.

Loudspeaker

Your phone has a loudspeaker for handsfree use. The loudspeaker allows you to speak and listen to the phone from a short distance without having to hold the phone to your ear, for example, having it on a table nearby. The loudspeaker can be used during a call, with sound applications, and when viewing multimedia messages. RealOne Player™ uses the loudspeaker by default when you watch a video. Using the loudspeaker makes it easier to use other applications while in a call.

Activating the loudspeaker

To change to using the loudspeaker during an already active call, select **Options**→**Activate loudsp.** A tone is played,  is shown in the navigation bar, and the volume indicator changes. See Fig. 8, p. 15.



Note: The loudspeaker cannot be activated when you have connected a headset to the phone.





Important: Do not hold the phone near to your ear when the loudspeaker is in use, because the volume may be extremely loud.

The loudspeaker needs to be activated separately each time for phone calls, but the sound applications such as Composer and Recorder use the loudspeaker by default.



Turning off the loudspeaker

- When you have an active call, select **Options**→**Activate handset**.

Headset mode

To adjust the volume level when a headset is connected to your phone, press  or  or use the headset's keys, if available.

Voice volume icons:

-  – for earpiece mode,
-  – for loudspeaker mode. See also Fig. 8, p. 15.

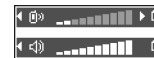

Fig. 8 Volume indicators for earpiece and loudspeaker modes are shown in the navigation bar.

Shared memory

The following features in your phone use shared memory: contacts, text messages, multimedia messages, images and ringing tones, Video recorder, RealOne Player™, calendar and to-do notes, and downloaded applications. Using any of these features leaves less memory for other features. This is especially true with heavy use of any of the features. For example, saving many images may take all of the shared memory and your phone may display that the memory is full. In this case, delete some of the information or entries reserving the shared memory.



2. Your phone

Making a call

- 1 In standby mode key in the phone number, including the area code. Press or to move the cursor. Press to remove a number.
 - For international calls, press twice for the international prefix (the + character replaces the international access code) and then key in the country code, the area code without 0, and the phone number.

Note: Calls described here as international may in some cases be made between regions of the same nation.
- 2 Press to call the number.
- 3 Press to end the call (or to cancel the call attempt).

Normal position: Hold the phone as you would hold any other telephone.

Note: Pressing will always end a call, even if another application is active and displayed.

To make a call using voice tags, see '[Making a call by saying a voice tag](#)', p. 49.

Making a call using the Contacts directory

- 1 To open the Contacts directory, go to **Menu** → **Contacts**.
- 2 To find a contact, scroll to the desired name. Or, key in the first letters of the name. The Search field opens automatically and matching contacts are listed.
- 3 Press to start the call.
If the contact has more than one phone number, scroll to the number and press to start the call.

Tip! To adjust the volume during a call, press to increase and to decrease the volume level.



Fig. 1 Making a call.





Tip! If your voice mail requires you to enter a password every time you call to listen to your voice messages, you may want to add a DTMF number after the voice mailbox number. This way the password is given automatically every time you call your voice mail. For example, +44123 4567p1234# where 1234 is the password and 'p' inserts a pause.



To view the speed dialling grid, go to **Menu**→**Tools**→**Speed dial**.

Calling your voice mailbox

The voice mailbox (network service) is an answering machine where callers who are unable to reach you can leave you voice messages.

- To call your voice mailbox, press  and  in standby mode.
- If the phone asks for the voice mailbox number, key it in and press **OK**. You can obtain this number from your service provider.



See also '[Settings for call diverting](#)', p. 21.

Each phone line may have its own voice mailbox number, see '[Line in use \(network service\)](#)', p. 30.

Changing the voice mailbox number

To change the phone number of your voice mailbox, go to **Menu**→**Tools**→**Voice mailbox** and select **Options**→**Change number**. Key in the number (obtained from your service provider) and press **OK**.

Speed dialling a phone number

- 1 Assign a phone number to one of the speed dialling keys ( - ), see '[Assigning speed dialling keys](#)', p. 49.
- 2 To call the number: In standby mode, press the corresponding speed dialling key and . If the *Speed dialling* function is set to *On*: Press and hold the corresponding speed dialling key until the call is started.



Making a conference call

Conference calling is a network service that allows you to make a conference call with a maximum of six participants, including yourself.

- 1 Make a call to the first participant.

- 2 To make a call to a new participant, select **Options**→*New call*. Key in or search the memory for the phone number of the participant and press **OK**. The first call is automatically put on hold.
- 3 When the new call has been answered, join the first participant in the conference call. Select **Options**→*Conference*.
- 4 To add a new person to the call, repeat step 2 and then select **Options**→*Conference*→*Add to conference*.
 - To have a private conversation with one of the participants: Select **Options**→*Conference*→*Private*. Scroll to the desired participant and press **Private**. The conference call is put on hold in your phone, and the other participants can still continue talking with each other while you have a private discussion with one participant only. Once you have finished the private conversation, select **Options**→*Add to conference* to return to the conference call.
 - To drop one participant from the conference call, select **Options**→*Conference*→*Drop participant*, then scroll to the participant and press **Drop**.
- 5 To end the active conference call, press .

Answering a call

- To answer an incoming call, press .
- To end the call, press .



If you do not want to answer a call, press .

 **Tip!** If you have activated the *Call divert*→*If busy* function to divert calls, for example, to your voice mailbox, rejecting an incoming call will also divert the call. See '[Settings for call diverting](#)', p. 21.

When a call comes in, press **Mute** to quickly mute the ringing tone.



Fig. 2 Conference call with two participants.

 **Tip!** The quickest way to make a new call is to dial the number and press  to start the call. The existing call is automatically put on hold.

 **Tip!** To adjust the phone tones for different environments and events, for example, when you want your phone to be silent, see '[Profiles](#)', p. 99.

 **Tip!** To end both calls at the same time, select **Options** → *End all calls* and press **OK**.

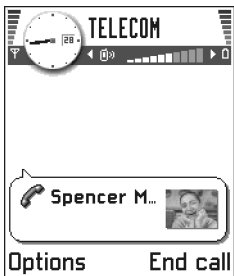





Fig. 3 Options during a call.

 **Note:** It is possible that the phone assigns a wrong name for the phone number. This happens if the phone number of the caller is not stored in Contacts but the seven last digits of the number match another number that is stored in Contacts. In this case, call identification is not correct.

Call waiting (network service)

If you have activated the Call waiting service, the network will notify you of a new incoming call while you have a call in progress. See '[Call waiting: \(network service\)](#)', p. 29.

- 1 During a call, press  to answer the waiting call. The first call is put on hold. To switch between the two calls, press **Swap**.
- 2 To end the active call, press .

Options during a call

Many options that you can use during a call are network services. Press **Options** during a call for some of the following options:



Mute or Unmute, End active call, End all calls, Hold or Unhold, New call, Conference, Private, Drop participant, Answer, and Reject.

Swap is used to switch between the active call and the call on hold.

Transfer is used to connect an incoming call or a call on hold with an active call and to disconnect yourself from both calls.

Send DTMF is used to send DTMF tone strings, for example, passwords or bank account numbers.

 **Glossary:**DTMF tones are the tones you hear when you press the number keys on the phone keypad. DTMF tones allow you to communicate with voice mailboxes and computerised telephony systems, for example.

- 1 Key in the digits with  - . Each keystroke generates a DTMF tone, which is transmitted while the call is active. Press  repeatedly to produce: *, **p** (inserts a

pause of approximately two seconds before, or between DTMF characters.), and **w** (if you use this character, the remaining sequence is not sent until you press **Send** again during the call). Press  to produce #.

- 2 To send the tone, press **OK**.



Tip! You can also store a sequence of DTMF tones for a contact card. When you make a call to the contact, you can retrieve the sequence. Add DTMF tones to the phone number or *DTMF* fields in a contact card.

Settings for call diverting

When this network service is activated, you can direct your incoming calls to another number, for example, to your voice mailbox number. For details, contact your service provider.

- Select one of the divert options, for example, select *If busy* to divert voice calls when your number is busy or when you reject incoming calls.
- Select **Options**→ *Activate* to set the divert setting on, *Cancel* to set the divert setting off, or *Check status* to check whether the divert is activated or not.
- To cancel all active diverts, select **Options**→ *Cancel all diverts*.

↔ Go to **Menu**→
Tools→ *Call divert*.

For information about the divert indicators, see '[Indicators related to actions](#)', p. 9.



Note: You cannot have barring of incoming calls and call diverting active at the same time. See '[Call barring \(network service\)](#)', p. 43.



Log – Call register and general log



In the log you can monitor phone calls, text messages, packet data connections, and fax and data calls registered by the phone. You can filter the log to view just one type of event and create new contact cards based on the log information.

↔ Go to **Menu**→ **Log**.

 **Tip!** To view a list of sent messages, go to **Messaging** → **Sent**.

 Go to **Menu** → **Log** → **Recent calls**.

Options in the Missed, Received, Dialed views: **Call**, **Use number**, **Delete**, **Clear list**, **Add to Contacts**, **Help**, and **Exit**.

Icons:  for missed,  for Received, and  for Dialed numbers views.



 **Note:** Connections to your remote mailbox, multimedia messaging centre, or browser pages are shown as data calls or packet data connections in the general communications log.

Recent calls register

The phone registers the phone numbers of missed, received, and dialed calls, and the approximate duration and cost of your calls. The phone registers missed and received calls only if the network supports these functions, and the phone is switched on and within the network's service area.



Missed calls and received calls

To view a list of the last 20 phone numbers from which somebody has tried to call you without success (network service), go to **Log** → **Recent calls** → **Missed calls**.

 **Tip!** When you see a note in standby mode about missed calls, press **Show** to access the list of missed calls. To call back, scroll to the number or name you want and press .

To view a list of the 20 numbers or names from which you have most recently accepted calls (network service), go to **Log** → **Recent calls** → **Received calls**.

Dialed numbers

 **Tip!** Press  in standby mode to open the Dialed numbers view. See Fig. 4, p. 24.

To view the 20 phone numbers that you have most recently called or attempted to call, go to **Log** → **Recent calls** → **Dialed nos.**

Erasing recent call lists

- To clear all recent call lists, select **Options** → **Clear recent calls** in the Recent calls main view.

- To clear one of the call registers, open the register you want to erase and select **Options**→ *Clear list*.
- To clear an individual event, open a register, scroll to the event, and press .

Call duration

Allows you to view the duration of your incoming and outgoing calls.





Note: The actual time invoiced for calls by your service provider may vary, depending upon network features, rounding-off for billing, and so forth.

Erasing call duration timers - Select **Options**→ *Clear timers*. For this you need the lock code, see [‘Security’](#), p. 38. To clear an individual event, scroll to it and press .

Call costs (network service)

Call costs allows you to check the cost of the last call or all calls. The call costs are displayed separately for each SIM card.

 Go to **Menu**→ **Log**→ *Call duration*.

 **Tip!** To see the call duration timer while you have an active call, select **Options**→ *Settings*→ *Show call duration*→ *Yes*.

 Go to **Log**→ *Call costs*.

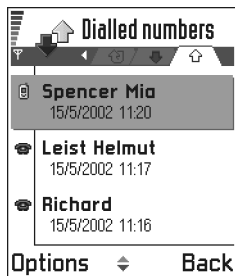



Fig. 4 The Dialled numbers view.

 **Note:** The actual invoice for calls and services from your service provider may vary, depending upon network features, rounding-off for billing, taxes and so forth.

Call costs limit set by a service provider

Your service provider can limit the cost of your calls to a certain amount of charging units or units of currency. When the limited charging mode is active, calls can be made only as long as the preset credit limit (call cost limit) is not exceeded and you are in a network that supports call cost limit. The number of remaining units is shown during a call and in standby mode. When the charging units have expired, the note *Call cost limit reached* is displayed. Contact your service provider for information on the limited charging mode and charging unit prices.

Cost shown as charging units or currency

- You can set the phone to show the remaining talk-time in charging units or units of currency. For this, you may need the PIN2 code, see p. 39.
 - 1 Select **Options** → **Settings** → **Show costs in**. The options are *Currency* and *Units*.
 - 2 If you choose *Currency*, a note requesting you to write the unit price is shown. Key in the cost of your home network charging or credit unit and press **OK**.
 - 3 Write a name for the currency. Use a three-letter abbreviation, for example, GBP.

 **Note:** When no more charging units or currency units are left, calls may only be possible to the emergency number programmed into your phone (e.g. 112 or other official emergency number).

Setting a call cost limit for yourself

- 1 Select **Options** → **Settings** → **Call cost limit** → **On**.
- 2 The phone requests you to enter the limit in units. For this you may need the PIN2 code. Depending on the *Show costs in* setting, enter either the amount of charging units or currency.

When the charging limit you have set yourself is reached, the counter stops at its maximum value and the note *Reset all calls' cost counter* is displayed. To be able to make

calls, go to **Options**→**Settings**→**Call cost limit**→**Off**. For this you need the PIN2 code, see p. 39.

Erasing call cost counters - Select **Options**→**Clear counters**. For this you need the PIN2 code, see p. 39. To clear an individual event, scroll to it and press .

GPRS data counter

Allows you to check the amount of data sent and received during packet data (GPRS) connections. For example, you may be charged for your GPRS connections by the amount of data sent and received.

 Go to **Log**→**GPRS counter**.



Viewing the general log

In the general log, for each communication event, you can see the sender or recipient name, phone number, name of the service provider, or access point. See Fig. 5, p. 26.



Note: Sub-events, such as a text message sent in more than one part and packet data connections, are logged as one communication event.

 Go to **Menu**→**Log** and press .

Icons:  for incoming,  for outgoing, and  for missed communication events.

Filtering the log

- 1 Select **Options**→**Filter**. A list of filters opens.
- 2 Scroll to a filter and press **Select**.

Erasing the contents of the log

- To erase all the log contents, Recent calls register, and Messaging delivery reports permanently, select **Options**→**Clear log**. Confirm by pressing **Yes**.



Fig. 5 The general log.

➔ Go to **Menu** → **SIM**.

Options in the SIM directory: *Open, Call, New SIM contact, Edit, Delete, Mark/Unmark, Copy to Contacts, My numbers, SIM details, Help, and Exit.*

Packet data counter and connection timer

- To view how much data, measured in kilobytes, has been transferred and how long a certain GPRS connection has lasted, scroll to an Incoming or Outgoing event with the access point icon  and select **Options** → *View details*.

Log settings

- Select **Options** → *Settings*. The list of settings opens.
 - Log duration* - The log events remain in the phone memory for a set number of days after which they are automatically erased to free memory.
 - ➔ **Note:** If you select *No log*, all the log contents, Recent calls register, and Messaging delivery reports are permanently deleted.
 - For *Call duration*, *Show costs in*, *Call cost limit*, see the sections '[Call duration](#)' and '[Call costs \(network service\)](#)' earlier in this chapter.



SIM folder

Your SIM card may provide additional services that you can access in this folder. See also '[Copying contacts between the SIM card and phone memory](#)', p. 45, 'Confirm SIM service actions', p. 40, 'Fixed dialling settings', p. 40, and '[Viewing messages on a SIM card](#)', p. 91.







➔ **Note:** For availability, rates and information on using SIM services, contact your SIM card vendor, e.g. network operator, service provider or other vendor.

- In the SIM directory, you can see the names and numbers stored on the SIM card, you can add or edit them, and you can make calls.



3. Settings

Changing general settings

- 1 Scroll to a setting group and press  to open it.
- 2 Scroll to a setting you want to change and press  to
 - switch between options if there are only two (On/Off).
 - open a list of options or an editor.
 - open a slider view, press  or  to increase or decrease the value, respectively, see Fig. 1, p. 27.



Note: You may be able to receive some settings from your service provider in a text message. See '[Receiving smart messages](#)', p. 83.



Phone settings

General

- *Phone language* - You can change the language for the display texts in your phone. This change will also affect the format used for date and time and the separators used, for example, in calculations. There are three languages installed in your phone. If you select *Automatic*, the phone selects the language according to the information on your SIM card. After you have changed the display text language, you must restart the phone.



Note: Changing the settings for *Phone language* or *Writing language* affects every application in your phone and the change remains effective until you change these settings again.

 Go to **Menu** →
Tools → **Settings**.

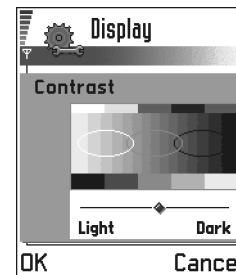













Fig. 1 A setting slider.



Tip! You can also make this change in some of the editors. Press  and select *Writing language*.



- *Writing language* - You can change the writing language of your phone permanently. Changing the language affects
 - the characters available when you press any key ( - ),
 - the predictive text dictionary used, and
 - the special characters that are available when you press the  and  keys.

 **Example:** You are using a phone where the display texts are in English but you want to write all your messages in French. After you change the language, the predictive text dictionary searches for words in French and the most common special characters or punctuation marks used in the French language are available when you press the  and  keys.
- *Dictionary* - To set the predictive text input *On* or *Off* for all editors in the phone. You can also change this setting when you are in an editor. Press  and select *Dictionary* → *Dictionary on* or *Off*.

 **Note:** The predictive text dictionary is not available for all languages.
- *Welcome note or logo* - Press  to open the setting. The welcome note or logo is displayed briefly each time you switch on the phone. Select *Default* if you want to use the default image or animation. Select *Text* to write a welcome note (max. 50 letters). Select *Image* to select a photo or picture from *Images*.
- *Orig. phone settings* - You can reset some of the settings to their original values. To do this, you need the lock code. See p. 39. After resetting the settings, the phone may take a longer time to power on.

 **Note:** All documents and files that you have created are left as they are.

Standby mode

- *Background image* - You can select any image to be used as a background image in standby mode. Select *Yes* to select an image from *Images*.
- *Left selection key* and *Right selection key* - You can change the shortcuts that appear over the left  and right  selection keys in standby mode. In addition to the applications, you can have the shortcut point to a function, for example, *New message*.



Note: You cannot have a shortcut to an application that you have installed.

Display

- **Contrast** - To change the contrast of the display to lighter or darker. See Fig. 1, p. 27.
- **Colour palette** - To change the colour palette used on the display.
- **Screen saver timeout** - The screen saver is activated when the screen saver time-out period is over. When the screen saver is active, the display is cleared and you can see the screen saver bar. See Fig. 2, p. 29.
 - To deactivate the screen saver press any key.
- **Screen saver** - Select what is shown on the screen saver bar: time and date or a text you have written yourself. See Fig. 2, p. 29. The location and background colour of the screen saver bar changes in one minute intervals. Also, the screen saver changes to indicate the number of new messages or missed calls.

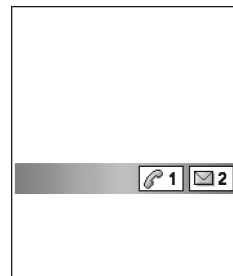

Fig. 2 The screen saver.



Call settings





Note: To change the settings for call diverting, go to **Menu** → **Tools** → **Call divert**. See '[Settings for call diverting](#)', p. 21.



Send my caller ID

- This network service allows you to set your phone number to be displayed (*Yes*) or hidden (*No*) from the person to whom you are calling. Or, the value may be set by your network operator or service provider when you make a subscription (*Set by network*).

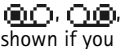
Call waiting: (network service)

- The network will notify you of a new incoming call while you have a call in progress. Select: *Activate* to request the network to activate call waiting, *Cancel* to request the network to deactivate call waiting, or *Check status*, to check if the function is active or not.

Voice message indicators:  or  is shown if you have one or several voice messages.

 **Tip:** To switch between the phone lines, press and hold  in standby mode.



Automatic redial

- When this setting is activated, your phone will make a maximum of ten attempts to connect the call after an unsuccessful call attempt. Press  to stop automatic redialling.



Summary after call

- Activate this setting if you want the phone to briefly display the duration and cost of the last call. To show costs, the *Call cost limit* needs to be activated for your SIM card. See p. 24.

Speed dialling

- Select *On* and the numbers assigned to the speed dialling keys ( - ) can be dialled by pressing and holding the key. See also '[Assigning speed dialling keys](#)', p. 49.

Anykey answer

- Select *On*, and you can answer an incoming call by briefly pressing any key, except , , and .

Line in use (network service)

- This setting is shown only if the SIM card supports two subscriber numbers, that is, two phone lines. Select which phone line (*Line 1* or *Line 2*) you want to use for making calls and sending text messages. Calls on both lines can be answered irrespective of the selected line.



Note: You will not be able to make calls if you select *Line 2* and have not subscribed to this network service.

To prevent line selection, select *Line change* → *Disable* if supported by your SIM card. To change this setting, you need the PIN2 code.



Connection

General information about data connections and access points

To define settings for access points, go to *Settings*→*Connection*→*Access points*.

A data connection is required to connect to an access point. Your phone supports three kinds of data connections:

- a GSM data call (**D**),
- GSM high-speed data call (**D***), or
- packet data (GPRS) connection (**G**).

There are three different kinds of access points that you can define: MMS access point, browser access point, and Internet access point (IAP). Check with your service provider what kind of an access point is needed for the service you wish to access. You need to set access point settings, if you want to, for example,

- send and receive multimedia messages,
- send and receive e-mail,
- browse pages,
- download Java™ applications,
- use Image upload, or
- use your phone as a modem.

See also '[Data connection indicators](#)', p. 10.

GSM data calls

A GSM data call enables data transmission rates to a maximum of 14.4 kbps. For availability and subscription to data services, contact your network operator or service provider.



Glossary: Access point - The point where your phone connects to the Internet by way of a data call or packet data connection. An access point can be provided, for example, by a commercial Internet service provider (ISP), service provider for mobile devices, or network operator.



Tip! The Settings wizard program included in the PC Suite for Nokia 3660 can help you to configure access point and mailbox settings. You can also copy existing settings, for example, from your computer to your phone. See the CD-ROM supplied in the sales package.

Minimum settings needed to make a data call

- To insert a set of basic GSM data call settings, go to **Settings**→**Connection**→**Access points** and select **Options**→**New access point**. Fill in the following: *Data bearer: GSM data, Dial-up number, Session mode: Permanent, Data call type: Analogue, and Maximum data speed: Automatic.*

High speed data call (High Speed Circuit Switched Data, HSCSD)



Glossary: High-speed data enables data transmission rates to a maximum of 43.2 kbps, which is three times faster than the standard data rates of the GSM network. HSCSD is comparable to the speed of many computer modems that communicate with today's fixed telephone networks.

For availability and subscription to high-speed data services, please contact your network operator or service provider.



Note: Sending data in HSCSD mode may drain the phone's battery faster than normal voice or data calls, as the phone may send data more frequently to the network.

Packet data (General Packet Radio Service, GPRS)



Glossary: Packet data, or General Packet Radio Service (GPRS), uses packet data technology where information is sent in short bursts of data over the mobile network. The benefit of sending data in packets is that the network is occupied only when sending or receiving data. Because GPRS uses the network efficiently, it allows for quick data connection set up and fast data transmission speeds.

Minimum settings needed to make a packet data connection

- You need to subscribe to the GPRS service. For availability and subscription to GPRS, contact your network operator or service provider.
- Go to **Settings**→**Connection**→**Access points** and select **Options**→**New access point**. Fill in the following: *Data bearer: GPRS* and *Access point name:* enter the name given to

you by your service provider. See ['Creating an access point'](#), p. 33 for further information.

Pricing for packet data and applications

Both the active GPRS connection and the applications used over GPRS require a fee, for example, using services, sending and receiving data, and text messages. For more detailed information on fees, contact your network operator or service provider. See also ['Packet data counter and connection timer'](#), p. 26.

Creating an access point

You may have preset access point settings in your Nokia 3660 mobile phone. Or, you may receive access point settings in a smart message from a service provider. See ['Receiving smart messages'](#), p. 83.

If there are no access points defined when you open [Access points](#), you will be asked if you want to create one.

If there already are access points defined, to create a new access point, select **Options**→[New access point](#) and select:

Options in the Access points list: [Edit](#), [New access point](#), [Delete](#), [Help](#), and [Exit](#).

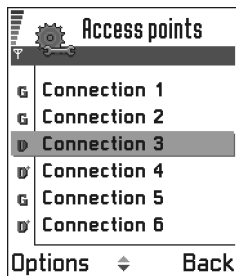



Fig. 3 A list of access points using different data connections.

Options when editing access point settings: [Change](#), [Advanced settings](#), [Help](#), and [Exit](#).

- [Use default settings](#) to use the default settings. Make the needed changes and press **Back** to save the settings.
- [Use existing settings](#) to use existing setting information as the basis for the new access point settings. A list of existing access points is opened. Select one and press **OK**. Access point settings are opened with some fields already filled.

Editing an access point

When you open Access points, the list of already available access points opens, see Fig. 3, p. 34. Scroll to the access point you want to edit, and press .

Deleting an access point

In the list of access points, scroll to the access point you want to remove and select **Options** → [Delete](#).

Access points

Here you can see a short explanation for every setting that may be needed for different data connections and access points.

 **Note:** Start to fill in the settings from the top because depending on what data connection you select ([Data bearer](#)) or whether you need to insert a [Gateway IP address](#), only certain setting fields are available.

 **Note:** Follow the instructions given to you by your service provider very carefully.

- [Connection name](#) - Give a descriptive name for the connection.
- [Data bearer](#) - The options are [GSM data](#), [High speed GSM](#), and [GPRS](#). Depending on what data connection you select, only certain setting fields are available. Fill in all fields marked with **Must be defined** or with a red asterisk. Other fields can be left empty, unless you have been instructed otherwise by your service provider.





Note: To be able to use a data connection, the network service provider must support this feature, and if necessary, activate it for your SIM card.

- **Access point name** (for packet data only) - The access point name is needed to establish a connection to the GPRS network. You obtain the access point name from your network operator or service provider.
- **Dial-up number** (for GSM data and high speed data only) - The modem telephone number of the access point.
- **User name** - Write a user name if required by the service provider. The user name may be needed to make a data connection, and is usually provided by the service provider. The user name is often case-sensitive.
- **Prompt password** - If you must key in a new password every time you log on to a server, or if you do not want to save your password to the phone, choose **Yes**.
- **Password** - A password may be needed to make a data connection, and is usually provided by the service provider. The password is often case-sensitive. When you are writing the password, the characters you enter are shown briefly and then changed to asterisks (*). The easiest way to enter numbers is to press  and select **Insert number** and then continue entering letters.
- **Authentication - Normal / Secure.**
- **Gateway IP address** - The IP address that the required browser gateway uses.
- **Homepage** - Depending on what you are setting up, write either:
 - the service address, or
 - the address of the multimedia messaging centre.
- **Connection security** - Choose whether Transport Layer Security (TLS) is used for the connection. Follow the instructions given to you by your service provider.
- **Session mode - Permanent / Temporary.**



Tip! See also ['Settings needed for multimedia messaging'](#), p. 77, ['Settings needed for e-mail'](#), p. 80, and ['Setting up the phone for the browser service'](#), p. 118.



Tip! When you are writing, press  to open the special characters table. Press  to enter a space.



Glossary: ISDN connections are a way to establish a data call between your phone and your access point. ISDN connections are digital from end to end and as such offer quicker set-up times and faster data rates than analogue connections. In order to use an ISDN connection, both your Internet service provider and network operator must support it.



Glossary: DNS - Domain Name Service. An Internet service that translates domain names such as www.nokia.com into IP addresses like **192.100.124.195**.

- *Data call type* (for GSM data and high speed data only) - *Analogue, ISDN v.110, or ISDN v.120* defines whether the phone uses an analogue or digital connection. This setting depends on both your GSM network operator and Internet Service Provider (ISP), because some GSM networks do not support certain types of ISDN connections. For details, contact your ISP. If ISDN connections are available, they establish connections more quickly than analogue methods.
- *Maximum data speed* (for GSM data and high speed data only) - The options are *Automatic* / 9600 / 14400 / 19200 / 28800 / 38400 / 43200, depending on what you have chosen in *Session mode* and *Data call type*. This option allows you to limit the maximum connection speed when high speed data is used. Higher data rates may cost more, depending on the network service provider.



Note: The speeds above represent the maximum speed at which your connection will operate. During the connection, the operating speed may be less, depending on network conditions.

Options → Advanced settings

- *Phone IP address* - The IP address of your phone.
- *Primary name server* - The IP address of the primary DNS server.
- *Second. name server* - The IP address of the secondary DNS server.



Note: If you need to enter the *Phone IP address*, *Primary name server*, or *Second. name server*, contact your Internet service provider to obtain these addresses.

The following settings are shown if you have selected data call and high speed data as the connection type:

- *Use callback* - This option allows a server to call you back once you have made the initial call, so you have a connection without paying for the call. Contact your service provider to subscribe to this service.



Note: Charges may apply for certain types of received calls, such as roaming and high speed data calls. Contact your GSM network operator for more information.



Note: The phone expects the callback call to use the same data call settings that were used in the callback-requesting call. The network must support that type of call in both directions, to and from the phone.

- **Callback type** - The options are *Use server no.* / *Use other no.* Ask your service provider for the correct setting to use; it will depend on the service provider's configuration.
- **Callback number** - Key in your phone's data phone number which the dial back server uses. Usually, this number is the data call phone number of your phone.
- **Use PPP compression** - When set to *Yes*, this option speeds up the data transfer, if supported by the remote PPP server. If you have problems with establishing a connection, try setting this to *No*. Contact your service provider for guidance.
- **Use login script** - The options are *Yes* / *No*.
- **Login script** - Insert the login script.
- **Modem initialisation** (Modem initialisation string)- Controls your phone using modem AT commands. If required, enter characters specified by your GSM network service provider or Internet service provider.

GPRS

The GPRS settings affect all access points using a packet data connection.

GPRS connection - If you select *When available* and you are in a network that supports packet data, the phone registers to the GPRS network and sending text messages will be done via GPRS. Also, starting an active packet data connection, for example, to send and receive e-mail, is quicker. If you select *When needed*, the phone will use a packet data connection only if you start an application or action that needs it. The GPRS connection is closed after it is not used by any application.



Note: If there is no GPRS coverage and you have chosen *When available*, the phone will periodically try to establish a packet data connection.



Glossary: PPP (Point-to-Point Protocol) - a common networking software protocol that enables any computer with a modem and a phone line to connect directly to the Internet.



Go to *Settings* → *Connection* → *GPRS*.

Go to [Settings](#) → [Connection](#) → [Data call](#).



Tip! See also the Language settings, p. [27](#).

Access point - The access point name is needed when you want to use your phone as a packet data modem to your computer. For more information on modem connections, see p. [138](#).

Data call

The Data call settings affect all access points using a data call and high speed data call.

Online time - If there are no actions the data call is dropped automatically after a time-out period. The options are *User defined*, in which case you enter a time, or *Unlimited*.



Date and time

- The date and time settings allow you to define the date and time used in your phone, as well as change the date and time format and separators. Choose *Clock type* → *Analogue* or *Digital* to change the clock shown in standby mode. Choose *Auto time update* if you want the mobile phone network to update time, date, and time zone information to your phone (network service).



Note: For the *Auto time update* setting to take effect, the phone needs to be restarted.



Security

Phone and SIM

Explanations for the different security codes that may be needed:

- PIN code (4 to 8 digits)** - The PIN (Personal Identification Number) code protects your SIM card against unauthorised use. The PIN code is usually supplied with the SIM card.

After three consecutive incorrect PIN code entries, the PIN code is blocked. If the PIN code is blocked, you need to unblock the PIN code before you can use the SIM card again. See the information about the PUK code.

- **PIN2 code (4 to 8 digits)** - The PIN2 code, supplied with some SIM cards, is required to access some functions, such as call cost counters.
- **Lock code (5 digits)** - The lock code can be used to lock the phone and keypad to avoid unauthorised use.



Note: The factory setting for the lock code is **12345**. To avoid unauthorised use of your phone, change the lock code. Keep the new code secret and in a safe place separate from your phone.

- **PUK and PUK2 codes (8 digits)** - The PUK (Personal Unblocking Key) code is required to change a blocked PIN code. The PUK2 code is required to change a blocked PIN2 code. If the codes are not supplied with the SIM card, contact the operator whose SIM card is in your phone for the codes.

You can change the following codes: lock code, PIN code, and PIN2 code. These codes can only include the numbers from **0** to **9**.



Note: Avoid using access codes similar to the emergency numbers, such as 112, to prevent accidental dialling of the emergency number.

PIN code request - When the PIN code request is active, the code is requested each time the phone is switched on. Note that deactivating the PIN code request may not be allowed by some SIM cards.

PIN code / PIN2 code / Lock code - Open this setting if you want to change the code.

Autolock period - You can set an autolock period, a time-out after which the phone is automatically locked and can be used only if the correct lock code is entered. Key in a number for the time-out in minutes or select *None* to turn off the autolock period.

- To unlock the phone, key in the lock code.



Tip! To lock the phone manually, press . A list of commands opens. Select *Lock phone*.

➡ To view the list of Fixed dialling numbers, go to *Menu*→*SIM*→*Fixed dialling*.

Options in the Fixed dialling view: *Open*, *Call*, *New contact*, *Edit*, *Delete*, *Add to Contacts*, *Add from Contacts*, *Help*, and *Exit*.

 **Note:** When the phone is locked, calls may be possible to the emergency number programmed into your phone (e.g. 112 or other official emergency number).

Lock if SIM changed – Select *Yes* if you want the phone to ask for the lock code when an unknown, new SIM card is inserted into your phone. The phone maintains a list of SIM cards that are recognised as the owner's cards.

Fixed dialling – You can restrict your outgoing calls to selected phone numbers, if supported by your SIM card. You need the PIN2 code for this function. When this function is active, you can only call those phone numbers that are included in the fixed dialling list or which begin with the same digit(s) as a phone number on the list.

 **Note:** When Fixed Dialling is set on, calls may be possible to certain emergency numbers in some networks (e.g. 112 or other official emergency number).

- To add new numbers to the Fixed dialling list, select **Options**→*New contact* or *Add from Contacts*.

Closed user group (network service) – You can specify a group of people to whom you can call and who can call you. For more information, contact your network operator or service provider. Select: *Default* to activate the default group agreed on with the network operator, *On* if you want to use another group (you need to know the group index number), or *Off*.

 **Note:** When calls are limited to Closed User Groups, calls may be possible to certain emergency numbers in some networks (e.g. 112 or other official emergency number).

Confirm SIM services (network service) – To set the phone to display confirmation messages when you are using a SIM card service.

Certif. management

In the Certificate management main view, you can see a list of authority certificates that have been stored in your phone. Press  to see a list of user certificates, if available.

 **Glossary:** Digital certificates are used to verify the origin of browser pages and installed software. However, they can only be trusted if the origin of the certificate is known to be authentic.

Digital certificates are needed if you:

- want to connect to an online bank or another site or remote server for actions that involve transferring confidential information, or
- want to minimise the risk of viruses or other malicious software and be sure of the authenticity of software when downloading and installing software.

 **Important:** Note, however, that even if the use of certificates makes the risks involved in remote connections and software installation considerably smaller, they must be used correctly in order to benefit from increased security. The existence of a certificate does not offer any protection by itself; the certificate manager must contain correct, authentic, or trusted certificates for increased security to be available.

Viewing certificate details – checking authenticity

You can only be sure of the correct identity of a browser gateway or a server when the signature and the period of validity of a browser gateway or server certificate have been checked.

You will be notified on the phone's display:

- if the identity of the browser server or gateway is not authentic or
- if you do not have the correct security certificate in your phone.

Options in the certificate management main view: [Certificate details](#), [Delete](#), [Trust settings](#), [Mark/Unmark](#), [Help](#), and [Exit](#).

 **Glossary:** Authority certificates are used by some services, such as banking services, for checking signatures or server certificates or other authority certificates.

 **Glossary:** User certificates are issued to users by a Certifying Authority.

To check certificate details, scroll to a certificate and select **Options**→ [Certificate details](#). When you open certificate details, Certificate management checks the validity of the certificate and one of the following notes may appear:

- [Certificate not trusted](#) - You have not set any application to use the certificate. For more information, see the next section '[Changing the trust settings of an authority certificate](#)'.
 - [Expired certificate](#) - The period of validity has ended for the selected certificate.
 - [Certificate not valid yet](#) - The period of validity has not yet begun for the selected certificate.
 - [Certificate corrupted](#) - The certificate cannot be used. Contact the certificate issuer.
-  **Important:** Certificates have a restricted lifetime. If [Expired certificate](#) or [Certificate not valid yet](#) is shown even if the certificate should be valid, check that the current date and time in your phone are correct.



Changing the trust settings of an authority certificate

- Scroll to an authority certificate and select **Options**→ [Trust settings](#). Depending on the certificate, a list of the applications that can use the selected certificate is shown. For example:
 - [Services](#) / [Yes](#) - the certificate is able to certify sites.
 - [Application manager](#) / [Yes](#) - the certificate is able to certify the origin of new software.
 - [Internet](#) / [Yes](#) - the certificate is able to certify e-mail and imaging servers.
-  **Important:** Before changing these settings, you must make sure that you really trust the owner of the certificate and that the certificate really belongs to the listed owner.



Call barring (network service)

Call barring allows you to restrict the making and receiving of calls with your phone. For this function, you need the barring password, which you can obtain from your service provider.

- 1 Scroll to one of the barring options.
 - 2 Select **Options**→ *Activate* to request the network to set call restriction on, *Cancel* to set the selected call restriction off, or *Check status* to check if the calls are barred or not.
 - Select **Options**→ *Edit barrings passw.* to change the barring password.
 - Select **Options**→ *Cancel all barrings* to cancel all active call barrings.
-  **Note:** When calls are barred, calls may be possible to certain emergency numbers in some networks (e.g. 112 or other official emergency number).
-  **Note:** Call barring affects all calls, including data calls.
-  **Note:** You cannot have barring of incoming calls and call diverting or fixed dialling active at the same time. See '[Settings for call diverting](#)', p. 21 or 'Fixed dialling', p. 40.



Network

Network selection

- Choose *Automatic* to set the phone to automatically search for and select one of the cellular networks available in your area, or

**Glossary:**

Roaming agreement - An agreement between two or more network service providers to enable the users of one service provider to use the services of other service providers.

Indicators shown in standby mode:

 - a headset is connected.

 - a loopset is connected.

- Choose *Manual*, if you want to select the desired network manually from a list of networks. If the connection to the manually selected network is lost, the phone will sound an error tone and ask you to select a network again. The selected network must have a roaming agreement with your home network, that is, the operator whose SIM card is in your phone.

Cell info display

- Select *On* to set the phone to indicate when it is used in a cellular network based on Micro Cellular Network (MCN) technology and to activate cell info reception.



Accessory settings

Scroll to an accessory folder and open the settings:

- Select *Default profile* to select the profile you want to be activated each time when you connect a certain accessory to your phone. See '[Profiles](#)', p. 99.
- Select *Automatic answer* to set the phone to answer an incoming call automatically after five seconds time. If the Incoming call alert is set to *Beep once* or *Silent*, automatic answer cannot be in use.



Note: If you are using a loopset, you need to activate it separately. Open the Loopset folder and select *Use loopset* → *Yes*. If you have activated a loopset, the headset will use the same settings as the loopset.

4. Contacts

In Contacts, you can store and manage contact information, such as names, phone numbers, and addresses. See Fig. 1, p. 45.

Contacts use shared memory. See '[Shared memory](#)', p.16.

You can also add a personal ringing tone, voice tag, or a thumbnail image to a contact card. You can create contact groups, which allow you to send text messages or e-mail to many recipients at the same time.

 **Glossary:** Voice tags can be any spoken words, for example, a person's first name. Voice tags allow you to make phone calls simply by saying the word aloud.

Creating contact cards

- 1 Open Contacts and select **Options**→ *New contact*. An empty contact card opens.
- 2 Fill in the fields you want and press **Done**. The contact card is saved in the phone memory and closed, after which you can see it in the Contacts directory.

Copying contacts between the SIM card and phone memory

- To copy names and numbers from a SIM card to your phone, go to **Menu**→ **SIM**→ **SIM directory**. Select the name(s) you want to copy and select **Options**→ *Copy to Contacts*.
- If you want to copy a phone, fax, or pager number from Contacts to your SIM card, go to Contacts, open a contact card, scroll to the number, and select **Options**→ *Copy to SIM direct*.

 To open Contacts, press  in standby mode or go to **Menu**→ **Contacts**.



Fig. 1 The contacts directory.

Options in the Contacts directory: *Open, Call, Create message, New contact, Edit, Delete, Duplicate, Add to group, Belongs to groups, Mark/Unmark, Send, Contacts info, Help, and Exit.*

Options when editing a contact card: *Add thumbnail | Remove thumbnail, Add detail, Delete detail, Edit label, Help, and Exit.*

Editing contact cards

- 1 In the Contacts directory, scroll to the contact card you want to edit and press  to open it.
- 2 To change the information on the card, select **Options**→ *Edit*.
- 3 To save your changes and to return to the contact card view, press **Done**.



Deleting contact cards

- In the Contacts directory, scroll to the contact card you want to delete and select **Options**→ *Delete*.

To delete many contact cards

- 1 Mark the cards to be deleted. Scroll to a contact you want to delete and select **Options**→ *Mark*. A check mark is placed next to the contact card.
- 2 When you have marked all the contacts you want to delete, select **Options**→ *Delete*.





Tip! You can also mark many items if you press and hold  and simultaneously press . See also '[Actions common to all applications](#)', p. 13.

Adding and removing contact card fields



- 1 Open a contact card and select **Options**→ *Edit*.
- 2 To add an extra field, select **Options**→ *Add detail*.
To delete a field you do not need, select **Options** → *Delete detail*.
To rename a contact card field label, select **Options**→ *Edit label*.

Inserting a picture to a contact card

There are two different types of pictures you can add to a contact card. See '[Camera and Images](#)', p. 53 for more information on how to take and store pictures.

- To attach a small thumbnail image to a contact card, open a contact card, select **Options**→ *Edit* and then select **Options**→ *Add thumbnail*. See Fig. 2, p. 47. The thumbnail image is also shown when the contact is calling you.
 -  **Note:** After you attach a thumbnail image to a contact card, you can select *Add thumbnail* to replace the image with a different thumbnail or *Remove thumbnail* to remove the thumbnail from the contact card.
- To add an image to a contact card, open a contact card, and press  to open the Image view (). To attach an image, select **Options**→ *Add image*.

Viewing a contact card

Contact information view () shows all information inserted in the contact card. Press  to open the Image view (.

-  **Note:** Only fields that have information are displayed in the contact information view. Select **Options**→ *Edit* if you want to see all fields and add more data to the contact.

Assigning default numbers and addresses

If a contact has several phone numbers or e-mail addresses, to speed up calling and sending messages, you can define certain numbers and addresses to be used as the default.





- Open a contact card and select **Options**→ *Defaults*. A pop-up window opens, listing the different options.
 -  **Example:** Scroll to *Phone number* and press **Assign**. A list of phone numbers in the selected contact card is shown. Scroll to the one you want to have as the default and press . When you return back to the contact card view, you can see the default number underlined. See Fig. 2, p. 47.



Fig. 2 The contact information view

Options when viewing a contact card when the selection is on a phone number: *Call, Create message, Edit, Delete, Defaults, Add voice tag / Voice tags, Assign speed dial / Remove speed dial, Ringing tone, Copy to SIM direct, Send, Help, and Exit.*

 **Example:** You can use a person's name for a voice tag, for example, 'John's mobile'.

 **Tip!** To view a list of voice tags you have defined, select **Options** → **Contacts info** → **Voice tags** in the Contacts directory.

Voice dialling

You can make a phone call by saying a voice tag that has been added to a contact card. Any spoken word(s) can be a voice tag. Before using voice dialling, note that:

- Voice tags are not language dependent. They are dependent on the speaker's voice.
- Voice tags are sensitive to background noise. Record them and make calls in a quiet environment.
- Very short names are not accepted. Use long names and avoid similar names for different numbers.

 **Note:** You must say the name exactly as you said it when you recorded it. This may be difficult in, for example, a noisy environment or during an emergency, so you should not rely solely upon voice dialling in all circumstances.

Adding a voice tag to a phone number

 **Note:** Voice tags can only be added to phone numbers stored in the phone's memory. See '[Copying contacts between the SIM card and phone memory](#)', p. 45.

- 1 In the Contacts directory, scroll to the contact to which you want to add a voice tag and press  to open the contact card.
- 2 Scroll to the number to which you want to add the voice tag and select **Options** → **Add voice tag**.

 **Note:** You can have only one voice tag per contact card.

- 3 The text *Press Start, then speak after tone* is displayed. When recording, hold the phone at a short distance away from your mouth. After the starting tone, say clearly the word(s) you want to record as a voice tag.
 - Press **Start** to record a voice tag. The phone sounds a starting tone and the note *Speak now* is displayed.
- 4 After recording, the phone plays the recorded tag and the note *Playing voice tag* is displayed. If you do not want to save the recording, press **Quit**.

- 5 When the voice tag has been successfully saved, the note *Voice tag saved* is displayed and a beep sounds. A symbol  can be seen next to the number in the contact card.

 **Note:** Your phone may have 25 phone numbers to which voice tags are attached. If the memory becomes full, delete some of the voice tags.

Making a call by saying a voice tag

 **Note:** You must say the voice tag exactly as you said it when you recorded it.

- 1 In standby mode, press and hold . A short tone is played and the note *Speak now* is displayed.
 - 2 When you are making a call by saying a voice tag, the loudspeaker is in use. Hold the phone at a short distance away from your mouth and face and say the voice tag clearly.
 - 3 The phone plays the original voice tag, displays the name and number, and after 1.5 seconds dials the number of the recognised voice tag.
- If the phone plays the wrong voice tag or to retry voice dialling, press **Retry**.

 **Note:** When an application using a data call or GPRS connection is sending or receiving data, you cannot make a call by using voice dialling. To make a call by using a voice tag, end all active data connections.

Replaying, erasing, or changing a voice tag

To replay, erase, or change a voice tag, open a contact card and scroll to the number that has a voice tag (indicated by ) and select **Options** → *Voice tags* → then either

- *Playback* - to listen to the voice tag again, or
- *Delete* - to erase the voice tag, or
- *Change* - to record a new voice tag instead of the old one. Press **Start** to record.

Assigning speed dialling keys

Speed dialling is a quick way to call frequently used numbers. You can assign speed dialling keys to eight phone numbers. Number 1 is reserved for the voice mailbox.



Fig. 3 The speed dialling grid

- 1 Open the contact card for which you want a speed dialling key and select **Options**→ *Assign speed dial*. The speed dialling grid opens, showing you the numbers from 1–9. See Fig. 3, p. 50.
- 2 Scroll to a number and press **Assign**. When you return to the contact information view, you can see the speed dial icon next to the number. See Fig. 2, p. 47.
 - To call the contact by speed dialling, go to standby mode and press the speed dialling key and .

Adding a ringing tone for a contact card or group

You can set a ringing tone for each contact card and group. When that contact or group member calls you, the phone plays the chosen ringing tone (if the caller's telephone number is sent with the call and your phone recognises it).

- 1 Press  to open a contact card or go to the Groups list and select a contact group.
- 2 Select **Options**→ *Ringing tone*. A list of ringing tones opens.
- 3 Use the scroll key to select the ringing tone you wish to use for the contact or group and press **Select**.
 - To remove the ringing tone, select *Default tone* from the list of ringing tones.



Note: For an individual contact, the phone will always use the ringing tone that was assigned last. So, if you first change a group ringing tone and then the ringing tone of a single contact that belongs to that group, the ringing tone of the single contact will be used when the contact calls you the next time.

Sending contact information

- 1 In the Contacts directory, scroll to the card you want to send.
- 2 Select **Options**→ *Send* then select the method, the choices are: *Via text message*, *Via e-mail* (available only if the correct e-mail settings are in place), *via Infrared*, or *via Bluetooth*. The contact card you want to send has now become a 'business card'. For further information, see the '[Messaging](#)' chapter, '[Sending and receiving data via infrared](#)', p. [137](#), and '[Sending data via Bluetooth](#)', p. [133](#).
- You can add received business cards to your Contacts directory. See '[Receiving smart messages](#)', p. [83](#) for further information.



Glossary: When you send or receive contact information, the term 'business card' is used. A business card is a contact card in a format suitable to be sent in a text message, usually in 'vCard' format.

Managing contact groups

You can create contact groups, which can, for example, be used as distribution lists for sending text messages and e-mail. See also p. [50](#) for how to add a ringing tone for a group.

Creating contact groups

- 1 In the Contacts directory, press  to open the Groups list.
- 2 Select **Options**→ *New group*. See Fig. [4](#), p. [52](#).
- 3 Write a name for the group or use the default name *Group* and press **OK**.

Adding members to a group

- 1 In the Contacts directory, scroll to the contact you want to add to a group and select **Options**→ *Add to group*. A list of available groups opens.
- 2 Scroll to the group to which you want to add the contact and press .

Options in the Groups list view: *Open*, *New group*, *Delete*, *Rename*, *Ringing tone*, *Contacts info*, *Help*, and *Exit*.



Fig. 4 Creating a contact group.

Adding multiple members at a time

- 1 In the Groups list, open a group and select **Options**→ *Add members*.
- 2 Scroll to a contact and press  to mark it. Repeat this action on all the contacts you want to add and press **OK** to add them to the selected group.

Removing members from a group

- 1 Go to the Groups list, scroll to the group you want to modify, and press .
- 2 Scroll to the contact you want to remove and select **Options**→ *Remove from group*.
- 3 Press **Yes** to remove the contact from the group.

Importing data from other Nokia phones

You can move calendar, contacts and to-do data from many different Nokia phones to your Nokia 3660 using the PC Suite for Nokia 3660 Data Import application. Instructions for using the application can be found in the PC Suite online help on the CD-ROM.



5. Camera and Images

With the camera you can take pictures of people or events while on the move. The pictures are automatically saved in the Images application, where you can rename them and organise them in folders. You can also send photos to your friends in a multimedia message, as an e-mail attachment, or via a Bluetooth or infrared connection. The camera produces JPEG pictures.



Glossary: JPEG is a standardised image compression format. JPEG files can be viewed with the most common image viewers, image editors, and Internet browsers. You can recognise these files by their JPG extension.

Taking pictures



Note: Obey all local laws governing the taking of pictures. Do not use this feature illegally.



Note: Your phone must be switched on to use this function. Do not switch the phone on when wireless phone use is prohibited or when it may cause interference or danger.

- 1 Press **Camera** in standby mode. The Camera application opens and you can see the view to be captured.
In Fig. 1, p. 53, you can see the viewfinder and the cropping lines, which show you the image area to be captured. You can also see the image counter, which shows you how many images, depending on the selected image quality, fit in the memory of your phone.
- 2 To take a picture, press .

← Press **Camera** in standby mode or go to **Menu** → **Camera**.

Options before taking a picture: *Capture*, *Go to Images*, *Settings*, *Help*, and *Exit*.



Fig. 1 Finding a view to capture.



Options after a picture has been taken: *New image*, *Delete*, *Send*, *Rename image*, *Go to Images*, *Settings*, *Help*, and *Exit*.

 **Example:** If you set 'Beach' as the default image name, Camera will name all the pictures you take 'Beach', 'Beach(01)', 'Beach(02)', and so on, until you change the setting again.

 **Note:** Do not move the phone before the Camera application starts to save the photo. The photos are saved automatically in the Images application.

After the image has been saved:

- If you do not want to save the photo in the Images application, select **Options**→ *Delete*.
- To return to the viewfinder to take a new picture, press .
- You can insert an image into a contact card. See '[Inserting a picture to a contact card](#)', p. 46.



 **Note:** Camera goes into battery saving mode if there have been no key presses within a minute. To continue taking pictures, press .

Settings

In the Camera application settings, you can adjust the image quality setting and change the default image name.

- 1 Select **Options**→ *Settings*.
- 2 Scroll to the setting you want to change:
 - *Image quality - High, Normal, and Basic*. The better the image quality, the more memory the image consumes. See also '[Images and memory consumption](#)', p. 56.
 - *Default image name* - By default, Camera names photos in the format '*Image.jpg*'. *Default image name* allows you to set a name for the pictures taken. See the example in the side of the page.
 - *Memory in use* - Select whether you want to store your images in the phone memory or the memory card, if you use one.

Camera mode affects image size and orientation

With the different Camera modes, you can affect the size and orientation of the picture to be taken. See Fig. 2, p. 55. When you are taking a picture, press  or  to change between the different modes. Choose:

- **Standard** when you want to take normal landscape pictures,
- **Portrait** when you want to take a smaller icon-sized, vertical picture, which can be added to a contact card, or
- **Night** when the lighting is dim and the Camera needs a longer exposure time for the picture to be of good quality. Note that, in dim conditions, any movement while taking a picture may cause it to get blurred. The image size and orientation is the same for **Standard** and **Night**.

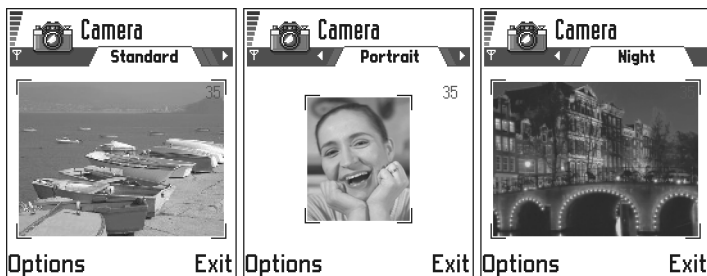

Fig. 2 Standard, Portrait, and Night modes

- When you are taking a picture in Standard or Night mode, the viewfinder resolution is 160x120 pixels and 80x96 for Portrait mode.
- The images taken in Standard or Night mode are saved in 640x480 pixel (VGA) format and those taken in Portrait mode are saved in 80x96 pixel format.



Tip! Try out the different Camera modes to see how they affect the picture taken.



Glossary:

Resolution - A measure for the sharpness and clarity of an image. Resolution refers to the number of dots (pixels) in an image or a display. The more pixels there are, the more detailed the picture is. Resolution is usually measured in pixels, for example, 640x480=300 kilopixels (kpix)=0.3 megapixels (Mpix).

- When you are viewing images, they are scaled to fit the display, which has 176x208 pixels. This means that Standard and Night mode pictures will appear more detailed when viewed on a higher resolution screen, for example, a computer or when zoomed in Images.

Images and memory consumption

Your phone has approximately 3 MB (megabytes) of free memory for images, contact information, calendar, messages, and so on. See '[Shared memory](#)', p. 16. Portrait images (always taken in High quality) are so small that they take up very little memory. Images taken using the High quality setting and those taken in Night mode take up the most memory.

If 1 MB of memory is used for images only, it would fit approximately 22 Normal quality images taken in Standard mode. In the table below, you can see approximately how many images would fit in 1 MB of memory.

Image quality Image type	Basic	Normal	High
Standard	55	22	15
Night	50	25	18
Portrait	-	-	>300



Tip! By using a memory card with your phone you can increase the number of images you can store.



Images - Storing pictures



Note: Your phone must be switched on to use this function. Do not switch the phone on when wireless phone use is prohibited or when it may cause interference or danger.

Images allows you to view, organise, delete, and send photos and pictures stored in your phone. In Images you can organise images:

- taken with the camera,
- sent to your Inbox in a multimedia or a picture message, as an e-mail attachment, via an infrared or Bluetooth connection. After receiving the image in Inbox, you need to save it in Images.

In Fig. 3, p. 58, you can see the Images main view, a list of photos and folders. In the list you can see:

- the date and time a photo or an image was taken or saved,
- a small thumbnail picture, a preview of the image,
- the number of items inside a folder, and
- a tab showing whether the photos or folders are located in the phone's memory or the memory card, if you use one.

Viewing images



Note: When you open **Images** and you use a memory card, the starting tab is determined by which memory is selected as the *Memory in use*.

- 1 Press  or  to move from one memory tab to another.
- 2 To browse the images, press  and .

 Go to **Menu** → **Images**.

Options in Images: *Open, Send, Image uploader, Delete, Move to folder, New folder, Mark/Unmark, Rename, Receive via infrared* (only from a digital camera that supports the IrTran-P protocol, otherwise use the '[Infrared connection](#)', see p. 136), *View details, Add to Favourites, Update thumbnails, Help, and Exit*.

Options when viewing an image: *Send, Rotate, Zoom in, Zoom out, Full screen, Delete, Rename, View details, Add to Favourites, Help, and Exit.*



Fig. 3 The Images main view

- 3 Press , to open an image. When the image is open, you can see the name of the image and the number of images in the folder on the top of the display.

When you are viewing an image, pressing  or  takes you to the next or previous picture in the current folder.

You can view animated GIF files in the same way as other images. Animations are played only once. When an animation stops, you will see a fixed image. To view the animation again, you must close it and then reopen it.

Zooming

- 1 Select **Options**→ *Zoom in* or *Zoom out*. You can see the zooming ratio at the top of the display, see Fig. 4, p. 59. See also section '[Keyboard shortcuts](#)' later in this chapter.
- 2 Press **Back** to return to the initial view.

 **Note:** The zoom ratio is not stored permanently.

 **Note:** You cannot zoom in on GIF animations while they are playing.

Full screen

When you select **Options**→ *Full screen*, the panes around the picture are removed so that you can see more of the image. Press  to go back to the initial view.

Moving the focus

When you are zooming or viewing an image in full screen mode, use the scroll key to move the focus to the left, right, up, or down, so that you can take a closer look at one part of the picture, for example, its upper right corner, as in Fig. 4, p. 59.

Rotating

Select **Options**→ *Rotate*→ *Left* to rotate an image 90 degrees anticlockwise or *Right* to rotate the image clockwise. The rotation status is not stored permanently.

Keyboard shortcuts











- Rotate:  - anticlockwise,  - clockwise
- Scroll:  - up,  - down,  - left,  - right
-  - zoom in,  - zoom out, press and hold to return to the normal view.
-  - change between full screen and normal view.

Image details view

- To view the detailed information about an image, scroll to the image and select **Options**→ *View details*. A list of image information appears:
Format - *JPEG, GIF, PNG, TIFF, MBM, BMP, WBMP, OTA, WMF, Unsupported, or Unknown.*
Date and *Time* - when the image was created or saved,
Resolutn. - the size of the image in pixels, see the glossary explanation, p. 55,
Size - in bytes or kilobytes (kb),
Colour - *True colour, 65536 colours, 4096 colours, 256 colours, 16 colours, Greyscale, or Black/white.*

Arranging images and folders

- To remove an image or folder, scroll to it and select **Options**→ *Delete*.
- To rename an image or a folder, scroll to the image or folder you want to rename and select **Options**→ *Rename*. Write the new name and press .





See '[Actions common to all applications](#)', p. 13 for further information on how to create folders and mark and move items to folders.



Fig. 4 Zooming in and moving the focus



Tip! You can send several images at a time via infrared or Bluetooth. To send several images at a time you need to mark them first. To mark several images at a time use the

Options → *Mark/Unmark* commands or press and hold  and at the same time press  or . As the selection moves, a check mark is placed next to the images. To end the selection, stop the scroll key and then release .

Options in the Picture messages folder: *Open*, *Send*, *Delete*, *Mark/Unmark*, *Rename*, *View details*, *Help*, and *Exit*.

Sending images

You can send photos or images via different messaging services.



- 1 Scroll to the image you want to send and select **Options** → *Send*.
- 2 Then select the method, the choices are *Via multimedia*, *Via e-mail*, *Via infrared*, and *Via Bluetooth*.
 - If you select to send the image in an e-mail or a multimedia message, an editor opens. Press  to select the recipient(s) from the Contacts directory or write the phone number or e-mail address of the recipient in the *To:* field. Add text or sound and select **Options** → *Send*. For more information, see '[Creating and sending new messages](#)', p. 74.
 - If you want to send the image via infrared or Bluetooth, see '[Sending data via Bluetooth](#)', p. 133, and '[Sending and receiving data via infrared](#)', p. 137 for more information.

Picture messages folder

In the Picture messages folder, you can find graphics sent to you in picture messages.

If you want to save a graphic you have received in a picture message, go to **Messaging** → *Inbox*, open the message, and select **Options** → *Save picture*.

Viewing pictures

- 1 Scroll to the picture you want to view and press . The picture opens. Press  to view the next picture in the folder.
- 2 Press **Back** to return to the Pictures main view.

6. Video recorder

 **Note:** Obey all local laws governing the taking of videos. Do not use this feature illegally.

 **Note:** Your phone must be switched on to use the Video recorder. Do not switch the phone on when wireless phone use is prohibited or when it may cause interference or danger.



With the Video recorder you can record video clips, and play video clips stored on your phone or on a memory card. Also, the Video recorder is integrated with the messaging features allowing you to easily send created clips.

Video recorder uses shared memory. See '[Shared memory](#)', p.16.

Recording a video clip

You can record video clips up to 95 kB in size, or approximately 10 seconds in duration. Recorded video clips are in the .3gp format.

 **Glossary:** 3GPP file format (.3gp) is the standard video file format for Multimedia Messaging.

- 1 To begin recording open the Video recorder and select **Options**→**Record** and you can see the view to record. See Fig. 1, p. 61.
- 2 To start recording press .
The progress bar on the bottom of the screen shows you how much recording time remains. To pause recording at any time press .

To immediately play the video clip you just recorded, press .

 Go to **Menu**→**Video recorder**.



Fig. 1 Recording a video clip

Options in video clip view of Video recorder: [Play](#), [Record](#), [Send](#), [Delete](#), [Rename](#), [Settings](#), [About product](#), [Help](#), and [Exit](#).



Fig. 2 Video clip list

The video clip is saved to either the phone's memory or the memory card, depending on the setting of your [Memory in use](#). See '[Setting up your Video recorder](#)', p. 62.

Watching a video clip

To watch a video clip from the Video recorder video clip list:

- 1 Open the Video recorder.
- 2 Scroll to a video clip and select **Options** → [Play](#). See Fig. 2, p. 62.

Once a video clip is playing, you have similar options available to you as when playing a video clip in '[RealOne Player™](#)'. See '[RealOne Player™](#)', p. 63.

Sending video clips

You can send video clips by using the [Send](#) option from your video clip list.

- 1 Scroll to the video clip you want to send and select **Options** → [Send](#).
- 2 Select one of the four ways you have of sending your video clip, [Via multimedia](#), [Via e-mail](#), [Via Bluetooth](#), or [Via infrared](#).

Setting up your Video recorder

You can define whether you store your video clips in the phone's memory or on the memory card, if you have one, and how to name your video clips.

Select **Options** → [Settings](#) and you have:

- [Memory in use](#) - Choose between [Phone memory](#) and [Memory card](#).
- [Default video name](#) - Define the default name of your video clips.



Example: If you set 'Holiday' as the default video clip name, Video recorder will name all the video clips you take 'Holiday', 'Holiday(01)', 'Holiday(02)', and so on, until you change the setting again.

1 7. RealOne Player™



Note: Your phone must be switched on to use this function. Do not switch the phone on when wireless phone use is prohibited or when it may cause interference or danger.

Go to [Menu](#) →
[RealOne Player](#).

With the RealOne Player™ you can play media files stored in the phone's memory or on a memory card, or play music and video files and stream live content from the Internet.



Glossary: Media files are video, music or audio clips which you can play on a media player like the RealOne Player. Files with extensions .3gp, .amr, .mp4, .rm, .ram, .ra and .rv. are supported by the RealOne Player.

RealOne Player does not necessarily support all the variations of all file formats supported. For example, RealOne Player will attempt to open all .mp4 files. However, some .mp4 files may include content that is not compliant with 3GPP standards and therefore is not supported by the Nokia 3660 phone. In this case, the operation might fail and result in partial playback or in an error message.

RealOne Player uses shared memory. See '[Shared memory](#)', p.16.

The Options menu shows different availability options as follows:

- When the list has no files, links, or folders: *Open, New folder, Settings, About product, Help* and *Exit*.
- When the selected item is a local file: *Play, Open, Rename* (if no items are marked), *Delete, New folder, Move to folder, Mark/Unmark, Send, Add to Favourites, Settings, About product, Help* and *Exit*.
- When the selected item is a network link: *Play* (if no items are marked), *Open, Rename, Edit link, Delete, New folder, Move to folder, Mark/Unmark, Send, Add to Favourites, Settings, About product, Help* and *Exit*.

Options: See adjacent list.

- When a folder is highlighted: *Open folder* (if no items are marked), *Open, Rename* (if no items are marked), *Delete, New folder, Mark/Unmark, Settings, About product, Help* and *Exit*.
- When many items are selected: *Open, Delete, New folder, Move to folder, Mark/Unmark, Send, Add to Favourites, Settings, About product, Help* and *Exit*.

Media Guide

From your RealOne Player you can open a browser page containing a Media Guide with links to streaming media sites and files. See [‘Streaming from the Internet’](#), p. 65.

Playing media files

You can play any music or video file from the list shown when you start the RealOne Player, or directly from the Internet.



Fig. 1 Music and video clip list



Fig. 2 Playing a local media file

- To play a media file stored in your phone's memory or memory card, open RealOne Player, scroll to the file and select **Options** → **Play**. See Fig. 1, p. 64, and Fig. 2, p. 64.

- To play a media file directly from the Internet:

- 1 Select **Options**→ *Open*→ *URL address*.
- 2 Enter the URL of the site you want to play or stream content from.



Note: You cannot connect to a site unless you have configured an Access Point, see *Default Access Point* setting, p. 67. Many service providers will require you to use an Internet Access Point (IAP) for your Default Access Point. Other service providers allow you to use a WAP access point. Contact your service provider for advice and availability.



Note: In the RealOne Player, you can only open an *rtsp://* URL address. You cannot open an *http://* URL address, however RealOne Player will recognise an *http* link to a *.ram* file since a *.ram* file is a text file containing an *rtsp* link.



Glossary:

Streaming is playing sound or video in real time as it is downloaded from the Internet, as opposed to storing it in a local file first.

Streaming from the Internet

- To stream live content from the Internet (network service), firstly configure your Default Access Point, see Note, p. 65. Then:
 - 1 Open RealOne Player and select **Options**→ *Open*→ *Guide*. Open the Media Guide to find a link to a streaming site which interests you.
 - 2 Select the link. You are prompted to disconnect the WAP access point.
 - If you have configured an Internet Access Point (IAP) as your Default Access Point in RealOne Player (with the agreement of your service provider), **accept** the prompt.
 - If you have configured a WAP access point as your Default Access Point in RealOne Player (with the agreement of your service provider), **decline** the prompt.

Your streaming session should now begin.

Before your media file or stream begins playing, your phone will connect to the site and load the file. See Fig. 3, p. 66.

For further information about setting up your Nokia 3660 phone for streaming with RealOne Player, please visit <http://www.nokia.com/phones/3660/support>.







**Glossary:**

Buffering is the temporary storage of a part of your streaming content into the phone's memory before it's played.



Fig. 3 Streaming a media file from the Internet; connecting, buffering then playing

Volume control

- To increase the volume press , or to decrease the volume press .
- To mute the sound press  and hold until the  indicator is displayed.
- To turn on the sound press  and hold until you see the  indicator, see Fig 2, p. 64.

Sending media files

You can send media files by using the *Send* option from your video clip list.

- 1 Scroll to the file you want to send and select **Options**→ *Send*.
- 2 Select one of the four ways you have of sending your file, via *Via infrared*, *Via Bluetooth*, *Via multimedia* or *Via e-mail*.

Changing the settings

To change the [Video](#) settings, select **Options**→ [Settings](#)→ [Video](#) to open the following list of settings:

- [Video quality](#) - Choose [Sharp images](#) to have better picture quality, but slower framerate, or [High framerate](#) for faster framerate, but lower picture quality.
- [Automatic scaling](#) - Choose [On](#) to have automatic resizing of the video image.

To change the [Playback](#) settings, select **Options**→ [Settings](#)→ [Playback](#) to open the following setting:

- [Repeat](#) - Choose [On](#) to have the playing video or audio file restart automatically once it has finished.



To change the [Network](#) settings, select **Options**→ [Settings](#)→ [Network](#) to open the following list of settings:

- [Default Access Point](#) - As defined in [Connection settings](#), see '[Access points](#)', p. [34](#). See also the guidance in Step 2, p. [65](#).
- [Bandwidth](#) - Choose [Automatic](#) to have the best delivery rate available.
- [Maximum bandwidth](#) - Choose the maximum bandwidth for streaming content.
- [Connection time-out](#) - Open the slider view to change the waiting time for the initial server connection on a streaming session.
- [Server time-out](#) - Open the slider view to change the time allowed for no response from the server.
- [Highest Port](#) and [Lowest Port](#) - Enter the port numbers for streaming. If you are not sure of the numbers, contact your service provider.

To change the [Proxy](#) settings, select **Options**→ [Settings](#)→ [Proxy](#) to open the following list of settings:

- [Use Proxy](#) / [Host address](#) / [Port](#) - Choose whether a proxy is used.



Tip! When you select one of the settings a tab view is opened. Press  or  to move between the different setting tabs. The following icons indicate which setting you are in:

 for [Video](#)

 for [Playback](#)

 for [Network](#), and

 for [Proxy](#).



8. Messaging

 Go to **Menu** → **Messaging**.

 **Note:** Your phone must be switched on to use the functions in the **Messaging** folder. Do not switch the phone on when wireless phone use is prohibited or when it may cause interference or danger.

In Messaging you can create, send, receive, view, edit, and organise:

- text messages,
- multimedia messages,
- e-mail messages, and
- smart messages, special text messages containing data.

Options in the Messaging main view: [Create message](#), [Connect](#) (shown if you have defined settings for the mailbox), or [Disconnect](#) (shown if there is an active connection to mailbox), [SIM messages](#), [Cell broadcast](#), [Service commands](#), [Settings](#), [Help](#), and [Exit](#).

In addition to these, you can receive messages and data via an infrared or Bluetooth connection, receive service messages, cell broadcast messages as well as send service commands.

Text and multimedia messages use shared memory. See '[Shared memory](#)', p.16.

When you open Messaging, you can see the [Create message](#) function and a list of default folders:

 **Inbox** - contains received messages except e-mail and cell broadcast messages. E-mail messages are stored in the [Mailbox](#). You can read cell broadcast messages by selecting **Options** → [Cell broadcast](#).

 **My folders** - for organising your messages into folders.

 **Mailbox** - When you open this folder, you can either connect to your remote mailbox to retrieve your new e-mail messages or view your previously retrieved e-mail messages offline. See p. [86](#) for further information on online and offline modes. After you have defined settings for a new mailbox, the name given to that mailbox will replace [Mailbox](#) in the main view. See '[Settings for e-mail](#)', p. [96](#).

 **Tip!** Organise your messages by adding new folders under My folders.

 **Drafts** – stores draft messages that have not been sent.

 **Outbox** – is a temporary storage place for messages waiting to be sent.

 **Sent** – stores the last 15 messages that have been sent. To change the number of messages to be saved, see '[Settings for the Other folder](#)', p. 98.

 **Reports** – you can request the network to send you a delivery report of the text messages, smart messages, and multimedia messages you have sent. To turn on delivery report reception, select **Options** → *Settings* → *Text message* or *Multimedia message*, scroll to *Receive report*, and select *Yes*.



 **Note:** Receiving a delivery report of a multimedia message that has been sent to an e-mail address might not be possible.

 **Note:** Before you can create a multimedia message, write an e-mail, or connect to your remote mailbox, you must have the correct connection settings in place. See '[Settings needed for e-mail](#)', p. 80 and '[Settings needed for multimedia messaging](#)', p. 77.



Messaging – General information

The message status is always either draft, sent, or received. Messages can be saved to the Drafts folder before they are sent. Messages are temporarily placed to Outbox to wait for sending. After a message has been sent, you can find a copy of the message in the Sent folder. Received and sent messages are in read-only state until you select *Reply* or *Forward*, which copies the message to an editor. Note that you cannot forward e-mail messages you yourself have sent.

 **Note:** Messages or data that have been sent via an infrared or Bluetooth connection are not saved in the Draft or Sent folders.



 **Tip!** When you have opened one of the default folders, for example, **Sent**, you can easily move between the folders: by pressing  to open the next folder (**Outbox**), or by pressing  to open the previous folder (**Drafts**).

Opening a received message

- When you receive a message,  and the note *1 new message* is shown in standby mode. Press **Show** to open the message.
- If you have more than one new message, press **Show** to open the Inbox to see the message headings. To open a message in Inbox, scroll to it and press .

Adding a recipient to a message

When you create a message, there are several ways to add a recipient:

- add recipients from the Contacts directory. To open the Contacts directory, press  or  in the *To:* or *Cc:* fields, or select **Options**→*Add recipient*. Scroll to a contact and press  to mark it. You can mark several recipients at a time. Press **OK** to return to the message. The recipients are listed in the *To:* field and automatically separated with a semicolon (;).
- write the phone number or e-mail address of the recipient in the *To:* field, or
- copy the recipient information from another application and then paste it to the *To:* field. See '[Copying text](#)', p. 73.

Press  to delete a recipient to the left of the cursor.



Note: If you write many phone numbers or e-mail addresses in the *To:* field, you must remember to add a semicolon (;) between each item to separate them from each other. When you retrieve recipients from the Contacts directory, the semicolon is added automatically.

Sending options

To change how a message is sent, select **Options**→*Sending options* when you are editing a message. When you save the message, its sending settings are also saved.













 **Example:** +44 123 456; 050 456 876

Writing text



You can key in text in two different ways, using the method traditionally used in mobile phones or another method called predictive text input.

Using traditional text input

The indicator  is shown on the top right of the display when you are writing text using traditional text input.

- Press a number key ( - ), repeatedly until the desired character appears. Note, that there are more characters available for a number key than are printed on the key.
- To insert a number, press and hold the number key.
- To switch between letter and number mode, press and hold .
- If the next letter is located on the same key as the present one, wait until the cursor appears (or press  to end the time-out period), and then key in the letter.
- If you make a mistake, press  to remove a character. Press and hold  to clear more than one character.
- The most common punctuation marks are available under . Press  repeatedly to reach the desired punctuation mark.
Press  to open a list of special characters. Use the scroll key to move through the list and press **Select** to select a character.
- To insert a space, press . To move the cursor to the next line, press  three times.
- To switch between upper and lower case, press .

Using predictive text input

To activate predictive text input, press  and select *Dictionary on*. This will activate predictive text input for all editors in the phone. The  indicator is shown at the top of the display.



Tip! To set predictive text input on or off, press  twice quickly when writing text.







Icons:  and  indicate the selected case.  means that the first letter of the next word is written in upper case, and all other letters will automatically be written in lower case.  indicates number mode.



Fig. 1 Predictive text input

- 1 Write the desired word by pressing the keys - . Press each key only once for one letter. The word changes after every key press.

Note: Do not pay attention to what appears on the display. The word match is evolving, wait until you have keyed in the whole word before you check the result.

For example, to write 'Nokia' when English dictionary is selected, press

for N, for o, for k, for i, and for a.

As you can see in Fig. 1, p. 72, the word suggestion changes after each key press.







- 2 When you have finished the word, check that it is correct.
 - If the word is correct, you can confirm it by pressing or by pressing to insert a space. The underlining disappears and you can begin to write a new word.
 - If the word is not correct, you have the following options:
 - Press repeatedly to view the matching words the dictionary has found one by one.
 - Press and select *Dictionary* → *Matches* to view a list of matching words. Scroll to the word you want to use and press to select it.
 - If the ? character is shown after the word, the word you intended to write is not in the dictionary. To add a word to the dictionary, press **Spell**, key in the word (max. 32 letters) using traditional text input, and press **OK**. The word is added to the dictionary. When the dictionary becomes full, a new word replaces the oldest added word.
 - To remove the ? and clear characters one by one from the word, press .

Tips on using predictive text input

- To erase a character, press . Press and hold to clear more than one character.
- To change between the different character cases **Abc**, **abc**, and **ABC**, press . Note that if you press quickly twice the predictive text input is turned off.
- To insert a number in letter mode, press and hold the desired number key.

Or press  and select *Insert number*, key in the numbers you want, and press **OK**.



To switch between letter and number mode, press and hold .

- The most common punctuation marks are available under . Press  and then  repeatedly to reach the desired punctuation mark. Press and hold  to open a list of special characters. Use the scroll key to scroll through the list and press **Select** to select a character. Or press  and select *Insert symbol*.
- Press  repeatedly to view the matching words the dictionary has found one by one.

You can also press , select *Dictionary* and select

- *Matches* - to view a list of words that correspond to your key presses. Scroll to the desired word and press the .
- *Insert word* - to add a word (max. 32 letters) to the dictionary by using traditional text input. When the dictionary becomes full, a new word replaces the oldest added word.
- *Edit word* - to open a view where you can edit the word, available only if the word is active (underlined).

Writing compound words



- Write the first half of a compound word and confirm it by pressing . Write the last part of the compound word and complete the compound word by pressing  to add a space.

Turning predictive text input off

- Press  and select *Dictionary* → *Off* to turn predictive text input off for all editors in the phone.

Copying text

If you want to copy text to the clipboard, the following are the easiest methods:

- 1 To select letters and words, press and hold . At the same time, press  or . As the selection moves, text is highlighted.



Tip! The predictive text input will try to guess which commonly used punctuation mark (.,?!') is needed. The order and availability of the punctuation marks depend on the language of the dictionary.

- To select lines of text, press and hold . At the same time press or .
- 2 To end the selection, stop pressing the scroll key (while still holding).
- 3 To copy the text to clipboard, while still holding , press **Copy**.
Or, release and then press it once to open a list of editing commands, for example, **Copy** or **Cut**.
If you want to remove the selected text from the document, press .
- 4 To insert the text into a document, press and hold and press **Paste**.
Or, press once and select **Paste**.

Editing options

When you press , the following options appear (depending on the editing mode and situation you are in):

- **Dictionary** (predictive text input), **Alpha mode** (traditional text input), **Number mode**
- **Cut**, **Copy** - available only if text has been selected first.
- **Paste** - available only when text has been either cut or copied to the clipboard.
- **Insert number**, **Insert symbol**, and
- **Writing language**: - changes the input language for all editors in the phone. See '[Phone settings](#)', p. 27.

Creating and sending new messages

Note: When sending messages, your phone may display the word "**Sent**". This is an indication that the message has been sent by your phone to the message centre number programmed into your phone. This is not an indication that the message has been received at the intended destination. For more details about messaging services, check with your service provider.





Fig. 2 Creating a message, message types.

You can start to create a message in two ways:

- By selecting *New message* → *Create*: → *Text message*, *Multimedia message*, or *E-mail* in the Messaging main view, or
- Start to create a message from an application that has the option *Send*. In this case the file that was selected (such as an image or text) is added to the message.

Writing and sending text messages

- 1 Select *New message*. A list of message options opens. See Fig. 2, p. 74.
- 2 Select *Create*: → *Text message*. The editor opens with the cursor in the *To:* field. Press  to select recipient(s) from the Contacts directory or write the phone number of the recipient.
Press  to add a semicolon (;) to separate each recipient. Press  to move to the message field.
- 3 Write the message.



Note: Your phone supports sending of multiple text messages at the same time, therefore, the normal 160 characters limit for one text message can be exceeded. If your text exceeds 160 characters, it will be sent in two or more messages and message sending may cost you more.

In the navigation bar, you can see the message length indicator counting backwards from 160. For example, 10 (2) means that you can still add 10 characters for the text to be sent as two messages.

- 4 To send the message, select *Options* → *Send* or press .

Sending smart messages

Smart messages are special text messages that can contain data. You can send smart messages such as:

- picture messages,
- business cards containing contact information in generic (vCard) format,
- Calendar notes (vCalendar format).

Options in the text message editor: *Send*, *Add recipient*, *Insert*, *Delete*, *Message details*, *Sending options*, *Help*, and *Exit*.



Tip! You can also receive ringing tones, operator logos, or settings from service providers, see p. 83.



Fig. 3 Editing a picture message.

Options in the picture message editor: *Send, Add recipient, Insert, Remove picture, Delete, Message details, Help, and Exit.*

For more information, see '[Sending contact information](#)', p. 51, '[Sending calendar entries](#)', p. 105, and '[Sending bookmarks](#)', p. 120.

Creating and sending picture messages

Your phone allows you to send and receive picture messages. Picture messages are text messages that contain small black-and-white graphics. There are several default pictures available in the *Picture msgs.* folder in **Images**.



Note: This function can be used only if it is supported by your network operator or service provider. Only phones that offer picture message features can receive and display picture messages.

To send a picture message:

- 1 There are two possibilities, either:
 - Go to *Images* → *Picture msgs.* and select a picture to be sent. Select **Options** → *Send*, or
 - Select **Messaging** → *New message* → *Create: Text message* and select *Insert* → *Picture*.
- 2 Enter recipient information and add text. See Fig. 3, p. 76.
- 3 Select **Options** → *Send* or press .



Note: Each picture message is made up of several text messages. Therefore, sending one picture message may cost more than sending one text message.

Multimedia messages

A multimedia message can contain a combination of text and video clips, or text, images and sound clips, but not a combination of images and video clips.



Note: This function can be used only if it is supported by your network operator or service provider. Only devices that offer compatible multimedia message or e-mail features can receive and display multimedia messages. Devices that don't have these features may receive details of a link to a web page.

Settings needed for multimedia messaging

You may receive the settings as a smart message from your network operator or service provider. See '[Receiving smart messages](#)', p. 83.

For availability of and subscription to data services, please contact your network operator or service provider.

- 1 Go to **Menu**→**Tools**→**Settings**→**Connection settings**→**Access points** and define the settings for a multimedia messaging access point:

Connection name - Give a descriptive name for the connection.

Session mode - Select a data connection type: *GSM data*, *High speed GSM*, or *GPRS*.

Gateway IP address - enter the address, see the example in the side of the page.

Homepage - enter the address of the multimedia messaging centre.

- If you selected *GSM data* or *High speed GSM*, fill in: **Dial-up number** - a phone number for the data call.
- If you selected *GPRS*, fill in: **Access point name** - the name given to you by your service provider.

For further information on different data connections, see also '[Connection](#)', p. 31.

- 2 Go to **Messaging**→**Options**→**Settings**→**Multimedia message**. Open **Preferred connection** and select the access point you created to be used as the preferred connection. See also '[Settings for multimedia messages](#)', p. 94.

Setting up the memory in use

The memory in use defines whether the phone's memory or the memory card are used as default. To define the memory in use:

- Go to **Messaging** and select **Options**→**Settings**→**Other**→**Memory in use** and select either the phone's memory or the memory card, if one is used.

Creating multimedia messages







Note: When you are sending a multimedia message to any phone other than Nokia 3650, Nokia 3660 or Nokia 7650, it is recommended to use a smaller image







Example: Domain names such as **www.nokia.com** can be translated into IP addresses like **192.100.124.195**.

Options in the multimedia message editor: *Send*, *Add recipient*, *Insert*, *Preview message*, *Objects*, *Remove*, *Delete*, *Message details*, *Sending options*, *Help*, and *Exit*.

size and a sound clip that is no longer than 15 seconds. The default setting is *Image size: Small*. If you want to check the image size setting, go to **Messaging**→**Options**→**Settings**→**Multimedia message** or select **Options**→**Sending options** when you are creating a multimedia message. When you are sending a multimedia message to an e-mail address or another Nokia 3650, Nokia 3660 or a Nokia 7650, if possible, use the larger image size (network dependent). To change the setting, select **Options**→**Sending options**→**Image size**→**Large** when you are creating a multimedia message.

- 1 In Messaging, select **New message**→**Create**→**Multimedia message** and press .
- 2 Press  to select the recipient(s) from the Contacts directory or write the phone number or e-mail address of the recipient in the **To:** field. Add a semicolon (;) to separate each recipient. Press  to move to the next field.
- 3 You can add the different objects of the multimedia message in any order you want.
 - To add an image, select **Options**→**Insert**→**Image** or **New image**.
 **Tip!** If you are sending a multimedia message to an e-mail address, it is recommended to change the image size to bigger, select **Options**→**Sending options**→**Image size**→**Large**. When sending a multimedia message to another phone, use the default size *Small*.
 - To add a sound, select **Options**→**Insert**→**Sound clip** or **New sound clip**. When sound has been added, the  icon is shown in the navigation bar. See Fig. 4, p. 79.

- To add video, select **Options**→ *Insert*→ *Video clip*.
 - To write text, press .
 - If you select *Insert*→ *Image*, *Sound clip*, *Video clip*, or *Template*, a list of items opens. Scroll to the item you wish to add and press **Select**.
 -  **Note:** If you chose *Image*, first you need to select whether the image is stored in the phone's memory or the memory card, if one is used.
 - If you select *Insert*→ *New image*, Camera opens and you can take a new picture. Press **Remove** to remove the picture and take another instead.
 - If you select *Insert*→ *New sound clip*, Recorder opens and you can record a new sound. The new photo or sound is automatically saved and a copy is inserted in the message.
 -  **Note:** A multimedia message can contain only one photo and one sound or video clip.
- 4 To send the message, select **Options**→ *Send* or press .

Previewing a multimedia message

To see what the multimedia message will look like, select **Options**→ *Preview message*.

Removing an object from a multimedia message

To remove a multimedia object, select **Options**→ *Remove*→ *Image Video clip* or *Sound clip*. Press  to remove text.

Working with different media objects

To see all the different media objects included in a multimedia message, open a multimedia message and select **Options**→ *Objects* to open the Objects view.

In the Objects view, you can change the order of the different objects, delete objects, or open an object in a corresponding application.

In Fig. 5, p. 29, you can see a list of different objects and their file sizes.



Fig. 4 Creating a multimedia message

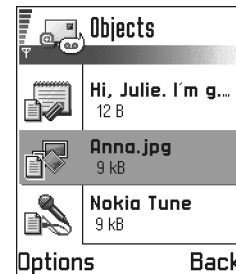

Fig. 5 Multimedia objects view.

Options in the Objects view: *Open, Insert, Place image first | Place text first, Remove, Help, and Exit.*

Options in the e-mail editor: *Send, Add recipient, Insert, Attachments, Delete, Message details, Sending options, Help, and Exit.*

E-mail

Settings needed for e-mail



Before you can send, receive, retrieve, reply to, and forward e-mail, you must:

- Configure an Internet Access Point (IAP) correctly. See '[Connection](#)', p. 31.
- Define your e-mail settings correctly. See '[Settings for e-mail](#)', p. 96.



Note: Follow the instructions given by your remote mailbox and Internet Service Provider.



Writing and sending e-mail messages

- 1 Select *New message* → *Create* → *E-mail*. The editor opens.
- 2 Press  to select the recipient(s) from the Contacts directory or write the e-mail address of the recipient in the *To*: field. Add a semicolon (;) to separate each recipient. If you want to send a copy of your e-mail to someone, write the address in the *Cc*: field. Press  to move to the next field.
- 3 Write the message. If you want to add an attachment to the e-mail, select **Options** → *Insert* → *Image, Sound clip, Video clip* or *Note*.  will appear in the navigation bar to indicate that the e-mail has an attachment. *Template* adds pre-written text to the e-mail.

You can also add an attachment to an e-mail by selecting **Options** → *Attachments* in an open e-mail. The Attachments view opens where you can add, view, and remove attachments.



Note: If you chose *Image*, first you need to select whether the image is stored in the phone's memory or the memory card, if one is used.

- 4 To remove an attachment, scroll to the attachment and select **Options**→ *Remove*.
 - 5 To send the e-mail, select **Options**→ *Send* or press .
-  **Note:** E-mail messages are automatically placed in Outbox before sending. In case something goes wrong while the phone is sending the e-mail, the e-mail is left to Outbox with the status *Failed*.

 **Tip!** If you want to send files other than photos, sounds, and notes as attachments, open the appropriate application and select the option *Send*→ *Via e-mail*, if available.









Inbox – receiving messages

Messages and data can be received via text message or multimedia service, via an infrared, or Bluetooth connection. When there are unread in Inbox, the icon changes to





In Inbox, the message icons tell you what kind of a message it is. Here are some of the icons that you may see:

-  for an unread text message and  for an unread smart message,
-  for an unread multimedia message,
-  for an unread service message,
-  for data received via infrared,
-  for data received via Bluetooth, and
-  for an unknown message type.

Options in Inbox: *Open*, *Create message*, *Delete*, *Message details*, *Move to folder*, *Mark/Unmark*, *Help*, and *Exit*.

Viewing messages in Inbox

- To open a message, scroll to the message and press . Use the scroll key to move up and down in the message. Press  or  to move to the previous or next message in the folder.

Options in different message viewers



The available options depend on the type of message you have opened for viewing:

- *Save picture* - saves the picture to **Images** → *Picture msgs.*
- *Reply* - copies the address of the sender to the *To:* field. Select *Reply* → *To all* - to copy the address of the sender and *Cc.* field recipients to the new message.
- *Forward* - copies the message contents to an editor.
- *Call* - call by pressing .
- *View image* - allows you to view and save the image.
- *Play sound clip* - allows you to listen to the sound in the message.
- *Objects* - shows you a list of all the different multimedia objects in a multimedia message.
- *Attachments* - shows you a list of files sent as e-mail attachments.
- *Message details* - shows detailed information about a message.
- *Move to folder* / *Copy to folder* - allows you to move or copy message(s) to My folders, Inbox, or other folders you have created. See 'Moving items to a folder', p. 14.
- *Add to Contacts* - allows you to copy the phone number or e-mail address of the message sender to the Contacts directory. Choose whether you want to create a new contact card or add the information to an existing contact card.
- *Find* - Searches the message for phone numbers, e-mail addresses, and Internet addresses. After the search, you can make a call or send a message to the found number or e-mail address, or save the data to Contacts or as a browser bookmark.

Viewing multimedia messages in Inbox

You can recognise multimedia messages by their icon :

- To open a multimedia message, scroll to it and press . You can see an image, read a message and hear a sound, simultaneously.

If sound is playing, press  or  to increase or decrease the sound volume. If you want to mute the sound, press **Stop**.



Multimedia message objects

- To see what kinds of media objects have been included in the multimedia message, open the message and select **Options**→ *Objects*. In the Objects view you can view files that have been included in the multimedia message. You can choose to save the file in your phone or to send it, for example, via infrared to another device.
- To open a file, scroll to it and press .



Important: Multimedia message objects may contain viruses or otherwise be harmful to your phone or PC. Do not open any attachment if you are not sure of the trustworthiness of the sender. For more information, see '[Certif. management](#)', p. 41.

Sounds in a multimedia message

Sound objects in a multimedia message are indicated by  indicator in the navigation bar. Sounds are by default played through the loudspeaker. To stop the sound, press **Stop** while sound is playing. You can change the volume level by pressing  or .

- If you want to listen to a sound again after all the objects have been shown and the playing of the sound has stopped, select **Options**→ *Play sound clip*.

Receiving smart messages

Your phone can receive many kinds of smart messages, text messages that contain data (also called Over-The-Air (OTA) messages). To open a received smart message, open Inbox, scroll to the smart message () and press .

- *Picture message* - to save the picture in the *Picture msgs.* folder in **Images** for later use, select **Options**→ *Save picture*.
- *Business card* - to save the contact information, select **Options**→ *Save business card*.



Note: If certificates or sound files are attached to business cards, they will not be saved.

- *Ringtone* - to save the ringing tone to Composer, select **Options**→ *Save*.

Options in the Objects view: *Open*, *Save*, *Send*, *Help*, and *Exit*.



Example: You can open a vCard file and save the contact information in the file to Contacts.



Tip! If you receive a vCard file that has a picture attached, the picture will be saved to Contacts as well.



Tip! To later change the default access point settings for browser service or multimedia messaging, go to **Services**→**Options**→**Settings**→**Default access point** or **Messaging**→**Options**→**Settings**→**Multimedia message**→**Preferred connection**.

Options when viewing a service message:
[Download message](#), [Move to folder](#), [Message details](#), [Help](#), and [Exit](#).

- **Operator logo** - to save the logo, select **Options**→**Save**. The operator logo can now be seen in standby mode instead of the network operator's own identification.
- **Calendar entry** - to save the invitation to Calendar, select **Options**→**Save to Calendar**.
- **WAP message** - to save the bookmark, select **Options**→**Save to bookmarks**. The bookmark is added to the Bookmarks list in browser service.
 If the message contains both browser access point settings and bookmarks, to save the data select **Options**→**Save all**. Or, select **Options**→**View details** to view the bookmark and access point information separately. If you do not want to save all data, select a setting or bookmark, open the details and select **Options**→**Save to Settings** or **Save to bookmarks** depending on what you are viewing.
- **E-mail notification** - Tells you how many new e-mails you have in your remote mailbox. An extended notification may list more detailed information such as subject, sender, attachments, and so on.
- In addition, you can receive a text message service number, voice mailbox number, profile settings for remote synchronisation, access point settings for the browser, multimedia messaging or e-mail, access point login script settings, or e-mail settings. To save the settings, select **Options**→**Save to SMS sett.**, **Save to Voice mail**, **Save to settings**, **Save to Settings**, or **Save to e-mail sett.**

Service messages

You can order service messages (pushed messages) from service providers. Service messages are notifications of, for example, news headlines and they may contain a text message or address of a browser service. For availability and subscription, contact your service provider.

Service providers can update an existing service message every time a new service message is received. Messages can be updated even if you have moved them to another folder than Inbox. When service messages expire, they are deleted automatically.

Viewing service messages in Inbox

- 1 In Inbox, scroll to a service message (📧) and press .
- 2 To download or view the service, press **Download message**. The note *Downloading message* is displayed. The phone starts to make a data connection, if needed.
- 3 Press **Back** to return to Inbox.

Viewing service messages in the browser

When you are browsing, select **Options**→ *Read service msgs.* to download and view new service messages.



My folders

In My folders you can organise your messages into folders, create new folders, and rename and delete folders. Select **Options**→ *Move to folder, New folder, or Rename folder*. For more information, see 'Moving items to a folder', p. 14.

Templates folder

- You can use text templates to avoid rewriting messages that you send often. To create a new template, select **Options**→ *New template*.

Options in My folders:
Open, New message, Delete, Message details, Move to folder, New folder, Rename, Help, and Exit.



Remote mailbox

When you open this folder, you can either connect to your remote mailbox:

- to retrieve new e-mail headings or messages, or
- view your previously retrieved e-mail headings or messages offline.



Tip! The Settings wizard program included in the PC Suite for Nokia 3660 can help you configure access point and mailbox settings. You can also copy existing settings, for example, from your computer to your phone. See the CD-ROM supplied in the sales package.

If you select *New message* → *Create* → *E-mail* or *Mailbox* in the Messaging main view and you have not set up your e-mail account, you will be prompted to do so. See '[Settings needed for e-mail](#)', p. 80.

When you create a new mailbox, the name you give to the mailbox automatically replaces *Mailbox* in the Messaging main view. You can have several mailboxes (max. six).

Opening the mailbox

When you open the mailbox, you can choose whether you want to view the previously retrieved e-mail messages and e-mail headings offline or connect to the e-mail server.

- When you scroll to your mailbox and press , the phone asks you if you want to *Connect to mailbox?* Select *Yes* to connect to your mailbox or *No* to view previously retrieved e-mail messages offline.
- Another way to start a connection is to select *Options* → *Connect*.

Viewing e-mail messages when online

When you are online, you are continuously connected to a remote mailbox via a data call or a packet data connection. See also '[Data connection indicators](#)', p. 10, '[GSM data calls](#)', p. 31, and '[Packet data \(General Packet Radio Service, GPRS\)](#)', p. 32.



Note: If you are using the POP3 protocol, e-mail messages are not updated automatically in online mode. To see the newest e-mail messages, you need to disconnect and then make a new connection to your mailbox.

Viewing e-mail messages when offline

When you view e-mail messages offline, your phone is not connected to the remote mailbox. This mode may help you to save on connection costs. See p. 31 for further information.



To view e-mail messages offline, you must first retrieve e-mail messages from your mailbox, see the next section. After you have retrieved the e-mail messages to your phone, to end the data connection, select **Options**→ *Disconnect*.

You can continue reading the retrieved e-mail headings and/or the retrieved e-mail messages offline. You can write new e-mail messages, reply to the retrieved e-mail messages, and forward e-mail messages. You can order the e-mail messages to be sent the next time you connect to the mailbox. When you open *Mailbox* the next time and you want to view and read the e-mail messages offline, answer **No** to the *Connect to mailbox?* query.

Options when viewing e-mail headings: *Open, New message, Connect / Disconnect, Retrieve, Delete, Message details, Copy, Mark/Unmark, Help, and Exit.*

Retrieving e-mail messages from the mailbox

- If you are offline, select **Options**→ *Connect* to start a connection to a remote mailbox.

The remote mailbox view is similar to the Inbox folder in Messaging. You can move up and down in the list by pressing  or . The following icons are used to show the status of the e-mail:



- new e-mail (offline or online mode). The content has not been retrieved from the mailbox to your phone (the arrow in the icon is pointing outwards).



- new e-mail, the content has been retrieved from the mailbox (arrow pointing inwards).



- for e-mail messages that have been read.



- for e-mail headings that have been read and the message content has been deleted from the phone.



Fig. 6 Viewing e-mail messages.

Options when viewing an e-mail message: [Reply](#), [Forward](#), [Delete](#), [Attachments](#), [Message details](#), [Move to folder](#), [Add to Contacts](#), [Find](#), [Help](#), and [Exit](#).

- When you have an open connection to a remote mailbox, select **Options**→[Retrieve](#)→
 - [New](#) - to retrieve all new e-mail messages to your phone.
 - [Selected](#) - to retrieve only the e-mail messages that have been marked. Use the [Mark/Unmark](#) → [Mark](#) / [Unmark](#) commands to select messages one by one. See p. [13](#) for information on how to select many items at the same time.
 - [All](#) - to retrieve all messages from the mailbox.
 To cancel retrieving, press **Cancel**.
- After you have retrieved the e-mail messages, you can continue viewing them online. Select **Options**→[Disconnect](#) to close the connection and to view the e-mail messages offline.

Copying e-mail messages to another folder

If you want to copy an e-mail from the remote mailbox to a folder under My folders, select **Options**→[Copy](#). Select a folder from the list and press **OK**.



Opening e-mail messages

- When you are viewing e-mail messages either in online or offline mode, scroll to the e-mail you want to view and press  to open it. If the e-mail message has not been retrieved (arrow in the icon is pointing outwards) and you are offline and select [Open](#), you will be asked if you want to retrieve this message from the mailbox. Note that the data connection is left open after the e-mail has been retrieved. Select **Options**→[Disconnect](#) to end the data connection.

Disconnecting from mailbox

When you are online, select **Options**→[Disconnect](#) to end the data call or GPRS connection to the remote mailbox. See also '[Data connection indicators](#)', p. [10](#).

Viewing e-mail attachments

- Open a message that has the attachment indicator  and select **Options**→ *Attachments* to open the Attachments view. In the Attachments view, you can retrieve, open, or save attachments. You can also send attachments via infrared or Bluetooth.
-  **Important:** E-mail attachments may contain viruses or otherwise be harmful to your phone or PC. Do not open any attachment if you are not sure of the trustworthiness of the sender. For more information, see '[Certif. management](#)', p. [41](#).

Retrieving attachments to the phone

- If the attachment has a dimmed indicator, it has not been retrieved to the phone. To retrieve the attachment, scroll to it and select **Options**→ *Retrieve*.
-  **Note:** If your mailbox uses the IMAP 4 protocol, you can decide whether to retrieve e-mail headings only, messages only, or messages and attachments. With the POP3 protocol, the options are e-mail headings only or messages and attachments. For further information, see p. [96](#).

Opening an attachment

- 1 In the Attachments view, scroll to an attachment and press  to open it.
 - If you are online, the attachment is retrieved directly from the server and opened in the corresponding application.
 - If you are offline, the phone asks if you want to retrieve the attachment to the phone. If you answer *Yes*, a connection to the remote mailbox is started.
- 2 Press **Back** to return to the e-mail viewer.

Saving attachments separately

To save an attachment, select **Options**→ *Save* in the Attachments view. The attachment is saved in the corresponding application. For example, sounds can be saved in Recorder and text files (.TXT) in Notes.

-  **Note:** Attachments like images can be saved on the memory card, if one is used.

Options in the Attachments view: *Open*, *Retrieve*, *Save*, *Send*, *Delete*, *Help*, and *Exit*.





Tip! To save memory, you can remove attachments from an e-mail while retaining them on the e-mail server. Select **Options**→ *Delete* in the Attachments view.



Tip! Supported image formats are listed on p. [59](#). To see a list of other file formats supported by the Nokia 3660, go and see the product information at www.nokia.com.

Deleting e-mail messages

- To delete an e-mail from the phone while still retaining it in the remote mailbox.
Select **Options**→ *Delete*→ *Phone only*.
 **Note:** The phone mirrors the e-mail headings in the remote mailbox. So, although you delete the message content, the e-mail heading stays in your phone. If you want to remove the heading as well, you have to first delete the e-mail message from your remote mailbox and then make a connection from your phone to the remote mailbox again to update the status.
- To delete an e-mail from both the phone as well as from the remote mailbox.
Select **Options**→ *Delete*→ *Phone and server*.
 **Note:** If you are offline, the e-mail will be deleted first from your phone. During the next connection to the remote mailbox, it will be automatically deleted from the remote mailbox.
If you are using the POP3 protocol, messages marked to be deleted are removed only after you have closed the connection to the remote mailbox.

Undeleting e-mail messages when offline

To cancel deleting an e-mail from both the phone and server, scroll to an e-mail that has been marked to be deleted during the next connection () , and select **Options**→ *Undelete*.



Outbox

Outbox is a temporary storage place for messages that are waiting to be sent.

Status of the messages in Outbox

- **Sending** – A connection is being made and the message is being sent.
- **Waiting / Queued** – For example, if there are two similar types of messages in Outbox, one of them is waiting until the first one is sent.
- **Resend at** (time) – Sending has failed. The phone will try to send the message again after a time-out period. Press **Send** if you want to restart the sending immediately.
- **Deferred** – You can set documents to be 'on hold' while they are in Outbox. Scroll to a message that is being sent and select **Options**→ **Defer sending**.
- **Failed** – The maximum number of sending attempts has been reached. Sending has failed. If you were trying to send a text message, open the message and check that the Sending settings are correct.



Example: Messages are placed to Outbox, for example, when your phone is outside the network coverage area. You can also schedule e-mail messages to be sent the next time you connect to your remote mailbox.

Viewing messages on a SIM card

Before you can view SIM messages, you need to copy them to a folder in your phone.

- 1 In the Messaging main view, select **Options**→ **SIM messages**.
- 2 Select **Options**→ **Mark/Unmark**→ **Mark** or **Mark all** to mark messages.
- 3 Select **Options**→ **Copy**. A list of folders opens.
- 4 Select a folder and press **OK**. Go to the folder to view the messages.



Cell broadcast (network service)



You can receive messages on various topics, such as weather or traffic conditions from your service provider. For available topics and relevant topic numbers, contact your service provider. In the main view you can see:



In the Messaging main view, select **Options**→ **Cell broadcast**.

Options in Cell broadcast:

Open, Subscribe / Unsubscribe, Hotmark / Unhotmark, Topic, Settings, Help, and Exit.

- the status of the topic:  - for new, subscribed messages and  - for new, unsubscribed messages.
- the topic number, topic name, and whether it has been flagged () for follow-up. You will be notified when messages belonging to a flagged topic have arrived.



Note: A packet data (GPRS) connection may prevent cell broadcast reception. Contact your network operator for the correct GPRS settings. For further information on the GPRS settings, see '[Packet data \(General Packet Radio Service, GPRS\)](#)', p. 32.



Service command editor

 In the Messaging main view, select **Options**→ *Service commands*.

You can send service requests, such as activation commands for network services (also known as USSD commands), to your service provider. For more information, contact your service provider. To send a request:

- in standby mode or when you have an active call, key in the command number(s) and press **Send**, or
- if you need to enter letters as well as numbers, select **Messaging**→ **Options**→ *Service commands*.

Messaging settings

The Messaging settings have been divided into groups according to the different message types. Scroll to the settings you want to edit and press .

Settings for text messages



Go to **Messaging** and select **Options**→**Settings**→**Text message** to open the following list of settings:

- **Message centres** - Lists all the text message service centres that have been defined. See '[Adding a new text message centre](#)', p. 93.
- **Msg. centre in use** (Message centre in use)- Defines which message centre is used for delivering text messages and smart messages such as picture messages.
- **Receive report** (delivery report)- When this network service is set to **Yes**, the status of the sent message (**Pending**, **Failed**, **Delivered**) is shown in the Log. See p. 21.
- **Message validity** - If the recipient of a message cannot be reached within the validity period, the message is removed from the text message service centre. Note that the network must support this feature. **Maximum time** is the maximum amount of time allowed by the network.
- **Message sent as** - The options are **Text**, **Fax**, **Paging**, and **E-mail**. For further information, contact your network operator.
 **Note:** Change this option only if you are sure that your service centre is able to convert text messages into these other formats.
- **Preferred connection** - You can send text messages via the normal GSM network or via GPRS, if supported by the network. See '[Packet data \(General Packet Radio Service, GPRS\)](#)', p. 32.
- **Reply via same ctr.** (network service) - By setting this option to **Yes**, if the recipient replies to your message, the return message is sent using the same text message service centre number. Note that this may not work between all operators.

Adding a new text message centre



- 1 Open **Message centres** and select **Options**→**New msg. centre**.
- 2 Press , write a name for the service centre and press **OK**.

Options when editing text message centre settings: **New msg. centre**, **Edit**, **Delete**, **Help**, and **Exit**.

- 3 Press , press  and write the number of the text message service centre (**Must be defined**). Press **OK**. You need the message centre number to send text and picture messages. You receive the number from your service provider.
- To use the new settings, go back to the settings view. Scroll to *Msg. centre in use*, press  and select the new service centre.

Settings for multimedia messages

Go to **Messaging** and select **Options**→ *Settings*→ *Multimedia message* to open the following list of settings:

- **Preferred connection (Must be defined)** - Select which access point is used as the preferred connection for the multimedia message centre. See '[Settings needed for multimedia messaging](#)', p. 77.
 -  **Note:** If you receive multimedia message settings in a smart message and save them, the received settings are automatically used for the Preferred connection. See '[Receiving smart messages](#)', p. 83.
- **Secondary conn.-** Select which access point is used as the secondary connection for the multimedia message centre.
 -  **Note:** Both *Preferred connection* and *Secondary conn.* must have the same *Homepage* setting pointing to the same multimedia service centre. Only the data connection is different.
 -  **Example:** If your preferred connection uses a packet data connection, you may want to use high speed data or data call for the secondary connection. This way you are able to send and receive multimedia messages even when you are not in a network that supports packet data. For availability of and subscription to data services, please contact your network operator or service provider. See also '[General information about data connections and access points](#)', p. 31.
- **Multimedia reception** - Select:

Only in home net. - if you want to receive multimedia messages only when you are in your home network. When you are outside your home network, multimedia message reception is turned off.

Always on - if you want to receive multimedia messages always.

Off - if you do not want to receive multimedia messages or advertisements at all.

 **Important:**

- When you are outside your home network, sending and receiving multimedia messages may cost you more.
- If the settings *Only in home net.* or *Always on* have been selected, your phone can make an active data call or GPRS connection without your knowledge.
- *On receiving msg.* - Select:
 - Retr. immediately* - if you want the phone to retrieve multimedia messages instantly. If there are messages with Deferred status, they will be retrieved as well.
 - Defer retrieval* - if you want the multimedia messaging centre to save the message to be retrieved later. To retrieve the message later, set *On receiving msg.* to *Retr. immediately.*
 - Reject message* - if you want to reject multimedia messages. The multimedia messaging centre will delete the messages.
- *Allow anon. messages* - Select *No*, if you want to reject messages coming from an anonymous sender.
- *Receive adverts* - Define whether you want to receive multimedia message advertisements or not.
- *Receive report* - Set to *Yes*, if you want the status of the sent message (*Pending, Failed, Delivered*) to be shown in the Log. See p. 21.



Note: Receiving a delivery report of a multimedia message that has been sent to an e-mail address might not be possible.

- *Deny report sending* - Choose *Yes*, if you do not want your phone to send delivery reports of received multimedia messages.
- *Message validity* - If the recipient of a message cannot be reached within the validity period, the message is removed from the multimedia messaging centre. Note that the network must support this feature. *Maximum time* is the maximum amount of time allowed by the network.
- *Image size* - Define the size of the image in a multimedia message. The options are: *Small* (max. of 160*120 pixels) and *Large* (max. 640*480 pixels).
- *Default Speaker* - Choose *Loudspeaker* or *Handset*, if you want the sounds in a multimedia message to be played through the loudspeaker or the earpiece. For more information, see '*Loudspeaker*', p. 15.

Settings for e-mail

Go to **Messaging** and select **Options**→ *Settings*→ *E-mail*.

Open *Mailbox in use* to select which mailbox you want to use.

Settings for Mailboxes

Select *Mailboxes* to open a list of mailboxes that have been defined. If no mailboxes have been defined, you will be prompted to do so. The following list of settings is shown:

- *Mailbox name* - Write a descriptive name for the mailbox.
- *Access point in use (Must be defined)* - The Internet Access Point (IAP) used for the mailbox. Choose an IAP from the list. For more information on how to create an IAP, see also '*Connection*', p. 31.
- *My mail address (Must be defined)* - Write the e-mail address given to you by your service provider. The address must contain the @ character. Replies to your messages are sent to this address.
- *Outgoing mail server: (Must be defined)* - Write the IP address or host name of the computer that sends your e-mail.

Options when editing e-mail settings: *Edit*, *New mailbox*, *Delete*, *Help*, and *Exit*.

- *Send message* - Define how e-mail is sent from your phone. *Immediately* - A connection to the mailbox is started immediately after you have selected *Send*. *During next conn.* - E-mail is sent when you connect to your remote mailbox the next time.
- *Send copy to self* - Select *Yes* to save a copy of the e-mail to your remote mailbox and to the address defined in *My mail address*.
- *Include signature* - Select *Yes* if you want to attach a signature to your e-mail messages and to start to write or edit a signature text.
- *User name*: - Write your user name, given to you by your service provider.
- *Password*: - Write your password. If you leave this field blank, you will be prompted for the password when you try to connect to your remote mailbox.
- *Incoming mail server*: (**Must be defined**) - The IP address or host name of the computer that receives your e-mail.
- *Mailbox type*: - Defines the e-mail protocol your remote mailbox service provider recommends. The options are *POP3* and *IMAP4*.
 **Note:** This setting can be selected only once and cannot be changed if you have saved or exited from the mailbox settings.
- *Security* - Used with the POP3, IMAP4, and SMTP protocols to secure the connection to the remote mailbox.
- *APOP secure login* - Used with the POP3 protocol to encrypt the sending of passwords to the remote e-mail server. Not shown if IMAP4 is selected for *Mailbox type*.
- *Retrieve attachment* (not shown if the e-mail protocol is set to POP3) - To retrieve e-mail with or without attachments.
- *Retrieve headers* - To limit the number of e-mail headers you want to retrieve to your phone. The options are *All* and *User defined*. Used with the IMAP4 protocol only.

Settings for service messages

When you go to **Messaging** and select **Options** → **Settings** → **Service message**, the following list of settings opens:

- *Service messages* - Choose whether or not you want to receive service messages.

- *Authentic. needed* - Choose if you want to receive service messages only from authorised sources.

Settings for Cell broadcast

Check with your service provider whether Cell broadcast is available and what the available topics and related topic numbers are. Go to **Messaging**→**Options**→**Settings**→**Cell broadcast** to change the settings:

- *Reception* - *On* or *Off*.
- *Language* - *All* allows you to receive cell broadcast messages in every possible language. *Selected* allows you to choose in which languages you wish to receive cell broadcast messages. If the language you want could not be found in the list, select *Other*.
- *Topic detection* - If you receive a message that does not belong to any of the existing topics, *Topic detection*→*On* allows you to save the topic number automatically. The topic number is saved to the topic list and shown without a name. Choose *Off* if you do not want to save new topic numbers automatically.

Settings for the Other folder

Go to **Messaging** and select **Options**→**Settings**→**Other** to open the following list of settings:

- *Save sent messages* - Choose if you want to save a copy of every text message, multimedia message, or e-mail that you have sent to the Sent items folder.
- *No. of saved msgs.* - Define how many sent messages will be saved to the Sent items folder at a time. The default limit is 20 messages. When the limit is reached, the oldest message is deleted.
- *Memory in use* - Define memory store. Choices are phone's memory or memory card, if one is used.

9. Profiles

In Profiles, you can adjust and customise the phone tones for different events, environments, or caller groups. There are five preset profiles: *General*, *Silent*, *Meeting*, *Outdoor*, and *Pager*, which you can customise to meet your needs.



You can see the currently selected profile at the top of the display in standby mode. If the General profile is in use, only the current date is shown.

The tones can be default ringing tones, tones created in Composer, tones received in a message, or transferred to your phone via infrared, Bluetooth, or a PC connection and then saved to your phone.



Changing the profile

- 1 Go to **Menu**→ **Profiles**. A list of profiles opens. See Fig. 1, p. 99.
- 2 In the Profiles list, scroll to a profile and select **Options**→ **Activate**.

Customising profiles

- 1 To modify a profile, scroll to the profile in the Profiles list and select **Options**→ **Personalise**. A list of profile settings opens.
- 2 Scroll to the setting you want to change and press  to open the choices:
 - **Ringing tone** - To set the ringing tone for voice calls, choose a ringing tone from the list. When you scroll through the list, you can stop on a tone to listen to it before you make your selection. Press any key to stop the sound. If a memory card is used, tones stored on it have the  icon next to tone name. Ringing tones use shared memory. See '[Shared memory](#)', p.16.

 Go to **Menu**→ **Profiles**.

 **Shortcut:** To change the profile, press  in standby mode. Scroll to the profile you want to activate and press **OK**.

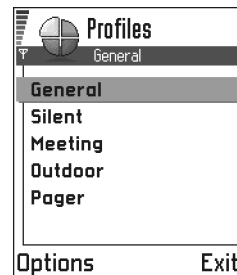

Fig. 1 The list of Profiles.

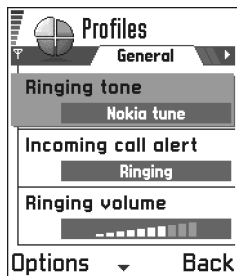



Fig. 2 Profile settings



 **Note:** You can change ringing tones in two places: Profiles or Contacts. See ['Adding a ringing tone for a contact card or group'](#), p. 50.

- *Incoming call alert* - When *Ascending* is selected, the ringing volume starts from level one and increases level by level to the set volume level.
- *Ringing volume* - To set the volume level for the ringing and message alert tones.
- *Message alert tone* - To set the tone for messages.
- *Vibrating alert* - To set the phone to vibrate at incoming voice calls and messages.
- *Keypad tones* - To set the volume level for keypad tones.
- *Warning tones* - The phone sounds a warning tone, for example, when the battery is running out of power.
- *Alert for* - To set the phone to ring only upon calls from phone numbers that belong to a selected contact group. Phone calls coming from people outside the selected group will have a silent alert. The choices are *All calls* / (list of contact groups, if you have created them). See ['Creating contact groups'](#), p. 51.
- *Profile name* - You can rename a profile and give it any name you want. The General profile cannot be renamed.

10. Favourites

 **Note:** Your phone must be switched on to use this function. Do not switch the phone on when wireless phone use is prohibited or when it may cause interference or danger.

You can use Favourites to store shortcuts, links to your favourite photos, video clips, notes, Recorder sound files, browser bookmarks, and saved browser pages.

The default shortcuts:  - opens the Notes editor,  - opens the Calendar with the current date selected,  - opens the Messaging Inbox. See Fig. 1, p. 101.

Adding shortcuts

Shortcuts can be added only from the individual applications. Not all applications have this functionality.

- 1 Open the application and scroll to the item that you want to add as a shortcut to Favourites.
- 2 Select **Options** → *Add to Favourites* and press **OK**.

 **Note:** A shortcut in Favourites is automatically updated if you move the item it is pointing to, for example, from one folder to another.

In Favourites:

- **To open a shortcut**, scroll to the icon and press . The file is opened in the corresponding application.
- **To delete a shortcut**, scroll to the shortcut you want to remove and select **Options** → *Delete shortcut*. Removing a shortcut does not affect the file it is referring to.
- **To change the shortcut heading**, select **Options** → *Edit shortcut name*. Write the new name. This change affects only the shortcut, not the file or item the shortcut refers to.

 Go to **Menu** → **Favourites**.

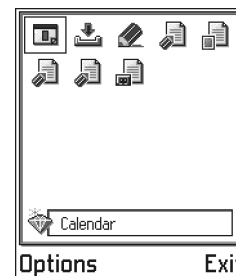

Fig. 1 The Favourites main view.

Options in the Favourites main view: *Open, Edit shortcut name, Shortcut icon, Delete shortcut, Move, List view | Grid view, Help, and Exit*.



11. Calendar and To-do

➔ Go to **Menu**→
Calendar



Note: Your phone must be switched on to use this function. Do not switch the phone on when wireless phone use is prohibited or when it may cause interference or danger.

Options when editing a calendar entry: *Delete*, *Send*, *Help*, and *Exit*.

In Calendar, you can keep track of your appointments, meetings, birthdays, anniversaries, and other events. You can also set a calendar alarm to remind you of upcoming events. Calendar uses shared memory. See '[Shared memory](#)', p.16.

Creating calendar entries



- 1 Select **Options**→ *New entry* and select:
 - *Meeting* to remind you of an appointment that has a specific date and time.
 - *Memo* to write a general entry for a day.
 - *Anniversary* to remind you of birthdays or special dates. Anniversary entries are repeated every year.
- 2 Fill in the fields, see the '[Calendar entry fields](#)' section, p. 103. See Fig. 1, p. 102. Use the scroll key to move between fields. Press  to change between upper and lower case.
- 3 To save the entry, press **Done**.

Fig. 1 Editing a calendar entry.

Editing calendar entries

- 1 In the Day view, scroll to the entry and press  to open it.
- 2 Edit the entry fields and press **Done**.





- If you are editing a repeated entry, choose how you want the changes to take effect: *All occurrences* - all repeated entries are changed / *This entry only* - only the current entry will be changed.



Deleting calendar entries

- In the Day view, scroll to the entry you want to delete and select **Options** → *Delete* or press . Press **Yes** to confirm.
- If you are deleting a repeated entry, choose how you want the change to take effect: *All occurrences* - all repeated entries are deleted / *This entry only* - only the current entry will be deleted.

 **Example:** Your weekly class has been cancelled. You have set the calendar to remind you every week. Choose *This entry only* and the calendar will remind you again next week.



Calendar entry fields

- *Subject* / *Occasion* - Write a description of the event.
 - *Location* - the place of a meeting, optional.
 - *Start time*, *End time*, *Start date*, and *End date*.
 - *Alarm* - Press  to activate the fields for *Alarm time* and *Alarm date*.
 - *Repeat* - Press  to change the entry to repeat. Shown with  in the Day view.
-  **Example:** The repeat function is handy if you have a recurring event, a weekly class, a biweekly meeting, or a daily routine you need to remember.
- *Repeat until* - You can set an ending date for the repeated entry, for example, the ending date of a weekly course you are taking. This option is shown only if you have selected to repeat the event.
 - *Synchronisation* - If you select *Private*, after synchronisation the calendar entry can be seen only by you and it will not be shown to others with online access to view the calendar. This is useful when, for example, you synchronise your calendar with a calendar on a compatible computer at work. If you select *Public*, the calendar entry is shown to others who have access to view your calendar online. If you select *None*, the calendar entry will not be copied to your PC when you synchronise your calendar.

 **Tip!** If you press  in Month, Week, or Day views, today's date is automatically highlighted.





Calendar entry icons in

Day and Week views:

-  - *Meeting*,
-  - *Memo*, and
-  - *Anniversary*.

Synchronisation icons in

Month view:

-  - *Private*,
-  - *Public*,
-  - *None*, and
-  - the day has more than one entry.

Calendar views

Month view

In the Month view, one row equals one week. Today's date is underlined. Dates that have calendar entries are marked with a small triangle at the right bottom corner. There is a frame around the currently selected date. See Fig. 2, p. 104.

- To open the Day view, scroll to the date you want to open and press .
- To go to a certain date, select **Options** → *Go to date*. Write the date and press **OK**.

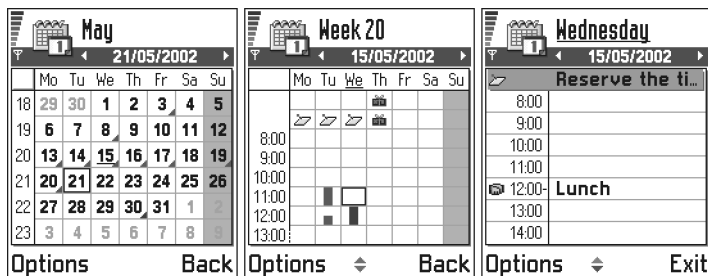



Fig. 2 Month, Week, and Day views in Calendar.



Week view

In the Week view, the calendar entries for the selected week are shown in seven day boxes. Today's day of the week is underlined. Memos and Anniversaries are placed before 8 o'clock. Meeting entries are marked with coloured bars according to starting and ending times. See Fig. 2, p. 104.

- To view or edit an entry, scroll to the cell that has an entry and press  to open the Day view, then scroll to the entry and press  to open it.

Day view

In the Day view, you can see the calendar entries for the selected day. The entries are grouped according to their starting time. Memos and Anniversaries are placed before 8 o'clock. See Fig. 2, p. 104.



- To open an entry for editing, scroll to it and press .
- Press  to go to the next day or press  to go to the previous day.

Settings for calendar views

Select **Options** → **Settings** and select:

- **Default view** - To select the view that is shown first when you open Calendar.
- **Week starts on** - To change the starting day of the week.
- **Week view title** - To change the title of the Week view to be the week number or the week dates.

Setting calendar alarms

- 1 Create a new Meeting or Anniversary entry, or open a previously created entry.
- 2 Scroll to **Alarm** and press  to open the **Alarm time** and **Alarm date** fields.
- 3 Set the alarm time and date.
- 4 Press **Done**. An alarm indicator  is shown next to the entry in the Day view.

Stopping a calendar alarm



- The alarm duration is one minute. When the alarm time expires, press **Stop** to end the calendar alarm. If you press any other key, the alarm is set to snooze.

Sending calendar entries

- In the Day view, scroll to the entry you want to send and select **Options** → **Send**. Then select the method, the choices are: **Via text message**, **Via e-mail** (available only if the correct e-mail settings are in place), **Via Bluetooth**, or **Via infrared**. For further

Options in the different calendar views: **Open**, **New entry**, **Week view / Month view**, **Delete**, **Go to date**, **Send**, **Settings**, **Help**, and **Exit**.



Shortcut: To write a calendar entry, press any key ( - ) in any calendar view. A Meeting entry is opened and the characters you keyed in are added to the **Subject** field.

➔ Go to **Menu** → **To-do**.



Fig. 3 Tasks in the To-do list.

information, see the '[Messaging](#)' chapter, '[Sending and receiving data via infrared](#)', p. [137](#), and '[Sending data via Bluetooth](#)', p. [133](#).



To-do

In To-do you can keep a list of tasks that you need to do. See Fig. [3](#), p. [106](#).

The To-do list uses shared memory. See '[Shared memory](#)', p. [16](#).

- 1 To start to write a to-do note, press any key (-). The editor opens and the cursor blinks after the letters you have keyed in.
- 2 Write the task in the *Subject* field. Press to add special characters.
 - To set the due date for the task, scroll to the *Due date* field and key in a date.
 - To set a priority for the to-do note, scroll to the *Priority* field and press .
- 3 To save the to-do note, press **Done**.



Note: If you remove all characters and press **Done**, the previously saved note will be deleted.

- To open a to-do note, scroll to it and press .
- To delete a to-do note, scroll to it and select **Options** → *Delete* or press .
- To mark a to-do note as completed, scroll to it and select **Options** → *Mark as done*.
- To restore a to-do note, select **Options** → *Mark as not done*.

Priority icons: - *High*, - *Low*, and (no icon) - *Normal*.

Status icons: - task completed and - not completed.

Importing data from other Nokia phones

You can move calendar, contacts and to-do data from many different Nokia phones to your Nokia 3660 using the PC Suite for Nokia 3660 Data Import application. Instructions for using the application can be found in the PC Suite online help on the CD-ROM.

12. Extras

 **Note:** Your phone must be switched on to use the functions in the **Extras** folder. Do not switch the phone on when wireless phone use is prohibited or when it may cause interference or danger.











Calculator

Go to **Menu** →
Extras → **Calculator**







Options in Calculator:
Last result, Memory, Clear screen, Help, and Exit.



Tip! Press  repeatedly to scroll the functions. You can see the selection change between the functions.

- 1 Enter the first number of your calculation. Press  to erase a mistake in the number.
- 2 Scroll to a function and press  to select it.
Use  to add,  to subtract,  to multiply, or  to divide.
- 3 Enter the second number.
- 4 To execute the calculation, scroll to  and press .











 **Note:** The Calculator has limited accuracy and rounding errors may occur, especially in long divisions.

- To add a decimal, press .
- Press and hold  to clear the result of the previous calculation.
- Use  and  to view previous calculations and move in the sheet.
- Select  to save a number to the memory, indicated by **M**. To retrieve the number from the memory, select .
- To retrieve the result of the last calculation, select **Options** → *Last result*.



Composer















Composer allows you to create your own, customised ringing tones. Note that it is not possible to edit a default ringing tone.

- 1 Select **Options**→ *New tone* to open the editor and to start composing.
 - Use the keys to add notes and rests. See the table.
Or, select **Options**→ *Insert symbol* to open a list of notes and rests. The default duration for a note is 1/4.
 - To listen to the tone, press  or select **Options**→ *Play*. To stop playing, press **Stop**.
 - To adjust the volume select **Options**→ *Volume* before you start to play the tone.
 - To adjust the tempo, select **Options**→ *Tempo*. To increase or decrease the tempo gradually, press  or , respectively. Tempo is measured in beats per minute. The maximum is 250 beats, the default tempo for a new tone is 160 beats, and the minimum is 50 beats.
 - To select many notes or rests at the same time, press and hold  and press and hold  or  at the same time.
 - To apply different playing styles, select two or more notes and then select **Options**→ *Style*→ *Legato* - notes are played in a smooth and even manner or select one or more notes and then select *Staccato* - notes are played separately to produce short sharp sounds.
 - To move note(s) up or down on the staff by a half step, scroll to the note and press  or .
 - To produce C#, press and hold  together with .
- 2 Press **Back** to save.

 Go to **Menu**→
Extras→ **Composer**.

Options in the Composer main view: *Open, New tone, Delete, Mark/Unmark, Rename, Duplicate, Help, and Exit.*

Options when composing: *Play, Insert symbol, Style, Tempo, Volume, Help, and Exit.*

Key	Note	Key and function
	c	 Shortens the duration of the selected note(s)/rest(s) in steps.
	d	 Lengthens the duration of the selected note(s)/rest(s) in steps.
	e	 Inserts a rest.
	f	Press  to open a list of notes and rests.
	g	 Switches octaves, all selected note(s) or rest(s) is/are moved to the next octave.
	a	 Deletes selected note(s).
	b	A long press of keys  -  produces a lengthened (dotted) note or rest or shortens a lengthened note.



Converter

➔ Go to **Menu** → *Extras*
→ **Converter**.



In Converter, you can convert measures such as *Length* from one unit (*Yards*) to another (*Metres*).





Note: The Converter has limited accuracy and rounding errors may occur.

Converting units

Options in Converter:
*Select unit | Change
currency, Conversion type,
Currency rates, Help, and
Exit.*

- 1 Scroll to the *Type* field and press  to open a list of measures. Scroll to the measure you want to use and press **OK**.
- 2 Scroll to the first *Unit* field and press  to open a list of available units. Select the unit **from** which you want to convert and press **OK**.
Scroll to the next *Unit* field and select the unit **to** which you want to convert.

- 3 Scroll to the first *Amount* field and key in the value you want to convert. The other *Amount* field changes automatically to show the converted value.
Press  to add a decimal and press  for the +, - (for temperature), and E (exponent) symbols.

 **Note:** The conversion order changes if you write a value in the second *Amount* field. The result is shown in the first *Amount* field.

Setting a base currency and exchange rates

Before you can make currency conversions, you need to choose a base currency (usually your domestic currency) and add exchange rates.

 **Note:** The rate of the base currency is always 1. The base currency determines the conversion rates of the other currencies.

- 1 Select *Currency* as the measure type and select **Options** → *Currency rates*. A list of currencies opens and you can see the current base currency at the top.
- 2 To change the base currency, scroll to the currency (usually your domestic currency), and select **Options** → *Set as base curr.*
 **Important:** When you change the base currency, all previously set exchange rates are set to 0 and you need to key in new rates.
- 3 Add exchange rates, scroll to the currency, and key in a new rate, that is, how many units of the currency equal one unit of the base currency you have selected. See the example on the side of the page.
- 4 After you have inserted all the needed exchange rates, you can make currency conversions, see '*Converting units*', p. 110.

 **Tip!** To rename a currency, go to the Currency rates view, scroll to the currency, and select **Options** → *Rename currency*.

 **Example:** If you set the Euro (EUR) as the base currency, a United Kingdom Pound (GBP) is approximately 1.63575 EUR. Thus, you would write 1.63575 as the exchange rate for the GBP.



Notes

← Go to **Menu** → **Extras**
→ **Notes**.

You can link notes to Favourites and send them to other devices. Plain text files (TXT format) you receive can be saved to Notes.

- Press (-) to start to write. Press to clear letters. Press **Done** to save.



Clock

← Go to **Menu** →
Extras → **Clock**.

Changing clock settings

- To change the time or date, select **Options** → **Settings** in Clock. To change the clock shown in standby mode, scroll down in the *Date and time* settings and select **Clock type** → *Analogue* or *Digital*.

Options in Clock: *Set alarm, Reset alarm, Remove alarm, Settings, Help, and Exit.*

Setting an alarm

- 1 To set a new alarm, select **Options** → *Set alarm*.
- 2 Enter the alarm time and press **OK**. When the alarm is active, the indicator is shown.



Note: The alarm clock works even if the phone is switched off.

- To cancel an alarm, go to clock and select **Options** → *Remove alarm*.

Turning off the alarm

- Press **Stop** to turn off the alarm.
- When the alarm tone sounds, press any key or **Snooze** to stop the alarm for five minutes, after which it will resume. You can do this a maximum of five times.

If the alarm time is reached while the phone is switched off, the phone switches itself on and starts sounding the alarm tone. If you press **Stop**, the phone asks whether you want to activate the phone for calls. Press **No** to switch off the phone or **Yes** to make and receive calls.



Note: Do not press **Yes** when wireless phone use is prohibited or when it may cause interference or danger.



Recorder

The voice recorder allows you to record telephone conversations and voice memos. If you are recording a telephone conversation, both parties will hear a tone every five seconds during recording.



Note: Obey all local laws governing recording of calls. Do not use this feature illegally.

- Select **Options** → *Record sound clip* and scroll to a function and press to select it. Use: - to record, - to pause, - to stop, - to fast forward, - to fast rewind, or - to play an opened sound file.



Note: Recorder cannot be used when a data call or a GPRS connection is active.

Games

To start a game, press **Menu** → **Games**, scroll to the game icon and press . For instructions on how to play the game, press **Options** → *Help*.



Go to **Menu** →
Extras → **Recorder**.

Options in Recorder: *Open, Record sound clip, Delete, Move to phone mem, Move to mem. card, Mark/Unmark, Rename sound clip, Send, Add to Favourites, Settings, Help, and Exit.*



Go to **Menu** →
Games.

← Go to **Menu** →
Extras → **Memory card**.



Memory card

If you have a memory card you can use it to store your multimedia files like video clips and sound files, photos, messaging information, and to backup information from your phone's memory.

The memory card in the sales package may contain promotional material of third parties which you can delete.



Important: Keep all memory cards out of the reach of small children.



Note: Details of how you can use the memory card with other features and applications of your Nokia 3660 are given in the sections describing these features and applications.

Options in the memory card: *Backup phone mem., Restore from card, Format mem. card, Memory card name, Set password, Change password, Remove password, Unlock memory card, Memory details, Help and Exit.*

To insert the memory card

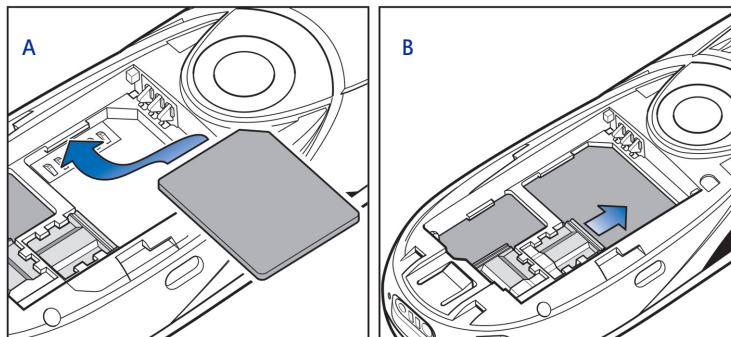





Fig. 1 Positioning and securing the memory card.

- 1 Make sure the phone is switched off. If it's on, press and hold  to switch off the phone.
- 2 With the back of the phone facing you, slide open the cover and remove the battery, see Quick start guide '[Insert the SIM card and load the battery](#)' for instructions on removing the cover.
- 3 Position the memory card in its slot as shown in Fig. 1 A, p. 114. Make sure that the gold contacts of the card are facing down.
- 4 Slide the silver catch over the memory card to secure it in its place, see Fig. 1 B, p. 114.
- 5 When you have secured the card in place, replace the battery, then replace the cover by sliding it back into place.

 **Important:** Do not remove the memory card in middle of an operation. Be sure to close all memory card applications before removing the card.

 **Important:** If you are installing an application to the memory card and need to reboot the phone, do not remove the card until the reboot is complete. Otherwise the application files may be lost.

Format memory card

You must format the memory card before you can use it for the first time.

- Select [Options](#)→ [Format mem. card](#).

You will be asked to confirm your request and once you confirm, formatting starts, see Fig. 2, p. 115.

Backing up and restoring information

You can backup information from your phone's memory to the memory card.

- Select [Options](#)→ [Backup phone mem.](#)

You can restore information from the memory card to the phone's memory.

- Select [Options](#)→ [Restore from card](#).

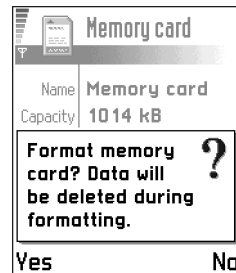

Fig. 2 Format memory card.

Memory card password

You can set a password to lock your memory card against unauthorised use.



Note: The password is stored in your phone and you don't have to enter it again while you are using the memory card on the same phone. If you use the memory card on another phone, you will be asked for the password.

To set, change, or remove your password

- Select **Options**→ *Set password*, *Change password*, or *Remove password*.

For every option you will be asked to enter and confirm your password. The password can be up to eight characters long.



Important: Once the password is removed, the memory card is unlocked and can be used on another phone without a password.

Unlocking a memory card

If you insert another password protected memory card in your phone, you will be prompted to enter the password of the card. To unlock the card,

- Select **Options**→ *Unlock memory card*.

Checking memory consumption

Using the *Memory details* option, you can check the memory consumption of different data groups and the available memory for installing new applications or software on your memory card.

- Select **Options**→ *Memory details*.

13. Services (XHTML)



 **Note:** Your phone must be switched on to use this function. Do not switch the phone on when wireless phone use is prohibited or when it may cause interference or danger.

Various service providers on the Internet maintain pages specifically designed for mobile phones, offering services such as news, weather reports, banking, travel information, entertainment, and games. With the XHTML browser you can view these services as WAP pages written in WML, XHTML pages written in XHTML, or a mixture of both.

 **Note:** Check the availability of services, pricing, and tariffs with your network operator and/or service provider. Service providers will also give you instructions on how to use their services.

Basic steps for accessing

- Save the settings that are needed to access the web service that you want to use. See the next section '[Setting up the phone for the browser service](#)'.
- Make a connection to the service. See p. 118.
- Start browsing the web pages. See p. 120.
- End the connection to the service. See p. 123.

 Go to **Menu** → **Services** or press and hold  in standby mode.

 **Glossary:** XHTML browser supports pages written in the Extensible Hypertext Markup Language (XHTML) and the Wireless Markup Language (WML).

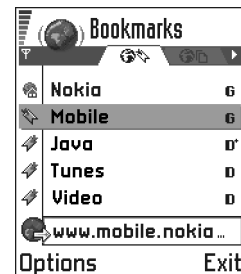



Fig. 1 The Bookmarks view with the Go to field at the bottom.



Tip! Settings may be available, for example, on the site of a network operator or service provider.



Tip! To access the Bookmarks view while browsing, press and hold down . To return to the browser view again, select **Options** → [Back to page](#).

Setting up the phone for the browser service

Receiving settings in a smart message

You may receive service settings in a special text message, a so-called smart message, from the network operator or service provider that offers the service. See '[Receiving smart messages](#)', p. [83](#). For more information, contact your network operator or service provider.

Keying in the settings manually



Follow the instructions given to you by your service provider.

- 1 Go to **Settings** → [Connection settings](#) → [Access points](#) and define the settings for an access point. See '[Connection](#)', p. [31](#).
- 2 Go to **Services** → **Options** → [Add bookmark](#). Write a name for the bookmark and the address of the browser page defined for the current access point.

Making a connection

Once you have stored all the required connection settings, you can access browser pages.

There are three different ways to access browser pages:

- Select the homepage () of your service provider,
- Select a bookmark from the Bookmarks view, or
- Press the keys  -  to start to write the address of a browser service. The Go to field at the bottom of the display is immediately activated and you can continue writing the address there.

After you have selected a page or written the address, press  to start to download the page. See also '[Data connection indicators](#)', p. [10](#).

Connection security

If the security indicator  is displayed during a connection, the data transmission between the phone and the browser gateway or server is encrypted and secure.



Note: The security icon does not indicate that data transmission between the gateway and the content server (place where the requested resource is stored) is secure. It is up to the service provider to secure data transmission between the gateway and the content server.

Viewing bookmarks



Glossary: A bookmark consists of an Internet address (mandatory), bookmark title, WAP access point, and if the service requires, a user name and password.



Note: Your phone may have some pre-installed bookmarks for sites not affiliated with Nokia. Nokia does not warrant or endorse these sites. If you choose to access them, you should take the same precautions, for security or content, as you would with any site.

In the Bookmarks view, you can see bookmarks pointing to different kinds of web pages. Bookmarks are indicated by the following icons:



- The starting page defined for the browser access point. If you use another web access point for browsing, the starting page is changed accordingly.



- The last visited page. When the phone is disconnected from the service, the address of the last visited page is kept in memory until a new page is visited during the next connection.



- A bookmark showing the title.

When you scroll through bookmarks, you can see the address of the highlighted bookmark in the Go to field at the bottom of the display. See Fig. 1, p. [117](#).

Options in the Bookmarks view (selection on a bookmark or folder): *Open, Download, Back to page, Send, Go to URL address / Find bookmark, Add bookmark, Edit, Delete, Read service msgs., Disconnect, Move to folder, New folder, Mark/Unmark, Rename, Clear cache, Details, Add to Favourites, Settings, Help, and Exit.*

Options when browsing:

Open, Service options, Bookmarks, History, Go to URL address, View image, Read service msgs., Save as bookmark, Send bookmark, Reload, Disconnect, Show images, Clear cache, Save page, Find, Details, Session, Security, Settings, Help, and Exit.

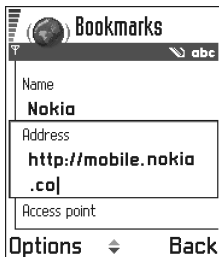

Fig. 2 Editing a bookmark.

Adding bookmarks manually

- 1 In the Bookmarks view, select **Options**→ *Add bookmark*.
- 2 Start to fill in the fields, see Fig. 2, p. 120. Only the address must be defined. The default access point is assigned to the bookmark if no other one is selected. Press to enter special characters such as /, ., :, and @. Press to clear characters.
- 3 Select **Options**→ *Save* to save the bookmark.

Sending bookmarks

- To send a bookmark, scroll to it and select **Options**→ *Send*→ *Via text message*.

Browsing

On a browser page, new links appear underlined in blue and previously visited links in purple. Images that act as links have a blue border around them. See Fig. 3, p. 121.

Keys and commands used in browsing

- To open a link, press .
- To scroll the view, use the scroll key.
- To enter letters and numbers in a field, press the keys - . Press to enter special characters such as /, ., :, and @. Press to clear characters.
- To go to the previous page while browsing, press **Back**. If **Back** is not available, select **Options**→ *History* to view a chronological list of the pages you have visited during a browsing session. The history list is cleared each time a session is closed.
- To check boxes and make selections, press .
- To retrieve the latest content from the server, select **Options**→ *Reload*.
- To open a sublist of commands or actions for the currently open web page, select **Options**→ *Service options*.

- Press and hold  to disconnect from a web service and to quit browsing.

Viewing new service messages while browsing

To download and view new service messages while browsing:

- 1 Select **Options**→ *Read service msgs.* (shown only if there are new messages).
- 2 Scroll to the message and press  to download and open it.

For more information about service messages, see '[Service messages](#)', p. 84.

Saving bookmarks

- To save a bookmark while browsing, select **Options**→ *Save as bookmark*.
- To save a bookmark received in a smart message, open the message in the Inbox in Messaging and select **Options**→ *Save to bookmarks*. See also '[Receiving smart messages](#)', p. 83.

Viewing saved pages

If you regularly browse pages containing information which doesn't change very often, for example a train timetable, you can save and then browse them when offline.

- To save a page, while browsing select **Options**→*Save page*.

Saved pages are indicated by the following icon:



- The saved web page.

In the saved pages view you can also create folders to store your saved web pages.

Folders are indicated by the following icon:



- Folder containing saved web pages.



Fig. 3 A web page.

Options in the Saved pages view: *Open, Back to page, Reload, Remove, Read service msgs., Disconnect, Move to folder, New folder, Mark/Unmark, Rename, Clear cache, Details, Add to Favourites, Settings, Help, and Exit.*



Fig. 4 The Saved pages view.

- To open the Saved pages view, press  in the Bookmarks view, see Fig. 4, p. 122. In the Saved pages view, press  to open a saved page.

If you want to start a connection to the web service and to retrieve the page again, select **Options**→*Reload*. You can also arrange the pages into folders.



Note: The phone stays online after you reload the page.

Downloading

You can download items such as ringing tones, images, operator logos and video clips through the mobile browser. These items can be provided free or for a price.

Once downloaded, items are handled by the respective applications on your phone, for example a downloaded photo will be saved in the **Images**.



Note: The information or services you have accessed are stored in the cache memory of the phone. A cache is a buffer memory that is used to store data temporarily. If you have tried to access or have accessed confidential information requiring passwords (for example, your bank account), empty the cache of your phone after each use. To empty the cache, select **Options**→*Clear cache*.

Downloading directly from the web page

To download the item directly from a web page:

- Scroll to the link and select **Options**→*Open*.

Purchasing an item



Note: Copyright protections may prevent some images, ringtones and other content from being copied, modified, transferred or forwarded.

To download the item:

- Scroll to the link and select **Options**→ *Open*.
- Choose the appropriate option to purchase the item, for example, Buy.

Checking an item before downloading

You can see details about an item before you download it. Details about an item may include the price, brief description and size.



Note: Check with your service provide to see if they offer this service.

- Scroll to the link and select **Options**→ *Open*.
Details about the item are displayed on your phone. See Fig. 5 on p. 123.
- If you want to continue with the downloading, press *Accept* or if you want to cancel the download, press *Cancel*.

Ending a connection

- Select **Options**→ *Disconnect*, or
- Press and hold to quit browsing and to return to standby mode.

Browser settings

- *Default access point* - If you want to change the default access point, press to open a list of available access points. The current default access point is highlighted. For more information, see '*Connection*', p. 31.



Glossary: Digital Rights Management (DRM) is a system for protecting the copyright of digital content that is distributed online.



Fig. 5 Example of details in a content file.

- *Show images* - Choose if you want to view pictures when you are browsing. If you choose *No*, you can later load images during browsing by selecting **Options**→ *Show images*.
- *Font size* - You can choose five text sizes in the browser: *Smallest*, *Small*, *Normal*, *Large*, and *Largest*.
- *Default encoding* - To make sure your browser pages display text characters correctly, select the appropriate language type.
- *Cookies - Allow / Reject*. You can enable or disable the receiving and sending of cookies.
- *Conf. DTMF sending - Always / First time only*. The browser supports functions you can access while browsing. You can: make a voice call while you are on a browser page, send DTMF tones while a voice call is in progress, save in Contacts a name and phone number from a browser page. Choose whether you want to confirm before the phone sends DTMF tones during a voice call. See also 'DTMF tones', p. 20.
- *Text wrapping* - Choose *Off* if you don't want the text in a paragraph to automatically wrap, or *On* if you do.



14. Applications (Java™)

 **Note:** Your phone must be switched on to use this function. Do not switch the phone on when wireless phone use is prohibited or when it may cause interference or danger.

In the Applications main view you can open installed Java applications or remove them. In the Install view you can install new Java applications (file extensions .JAD or .JAR).

 **Note:** Your phone supports J2ME™ Java applications. Do not download PersonalJava™ applications to your phone as they cannot be installed.

When you open Applications, you can see a list of Java applications that have been installed to your phone. See Fig. 1 on p. 125.

- Scroll to an application and select **Options**→ *View details* to view:
 - *Status* - *Installed*, *Running*, or *Downloaded* (shown only in Install view),
 - *Version* - the application version number,
 - *Supplier* - the supplier or manufacturer of the application,
 - *Size* - the size of the application file in kilobytes,
 - *Type* - a brief description of the application,
 - *URL* - an address of an information page on the Internet, and
 - *Data* - the size of application data such as high scores, in kilobytes.
- To start a data connection and to view extra information about the application, scroll to it and select **Options**→ *Go to URL address*.
- To start a data connection and to check if there is an update available for the application, scroll to it and select **Options**→ *Update*.

Applications uses shared memory. See '[Shared memory](#)', p.16.

 Go to **Menu**→
Applications

Options in the Applications main view:
Open, *View details*, *Settings*,
Remove, *Go to URL address*,
Update, *Help*, and *Exit*.

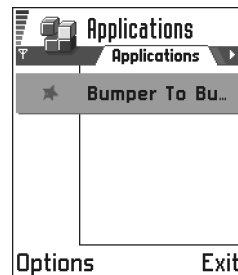



Fig. 1 Applications main view.

Options in the Install view: [Install](#), [View details](#), [Delete](#), [Help](#), and [Exit](#).

 **Example:** If you have received the installation file as an e-mail attachment, go to your mailbox, open the e-mail, open the Attachments view, scroll to the installation file, and press  to start the installation.

Installing a Java application

Installation files may be transferred to your phone from a computer, downloaded during browsing, or sent to you in a multimedia message, as an e-mail attachment, via Bluetooth, or via infrared. If you are using PC Suite for Nokia 3660 to transfer the file, place it in the `c:\nokia\installs` folder in your phone.



Important: Only install software from sources that offer adequate protection against viruses and other harmful software.

- 1 In the Applications main view, to view the installation packages, press  to open the *Downloaded* view.



Note: In the Install view, you can only install Java software installation files with the extension .JAD or .JAR.

- 2 To install an application, scroll to an installation file and select **Options** → *Install*. Alternatively, search the phone memory for the installation file, select the file, and press  to start the installation. See the example on the side of the page.
- 3 Press **Yes** to confirm the installation.

The .JAR file is required for installation. If it is missing, the phone may ask you to download it. If there is no access point defined for Applications, you will be asked to select one. When you are downloading the JAR file, you may need to enter a user name and password to access the server. You obtain these from the supplier or manufacturer of the application.

During installation, the phone checks the integrity of the package to be installed. The phone shows information about the checks being carried out, and you are given options whether to continue with or cancel the installation. Once the phone has checked the integrity of the software package, the application is installed on your phone.
- 4 The phone informs you when installation is complete.

To open the Java application after installation, you must go to the Applications main view.



Tip! When you are browsing WAP or browser pages, you can download an installation file and install it immediately. Note, however, that the connection is left running in the background during installation.

Opening a Java application

- Scroll to an application in the Applications main view and press  to open it.

Uninstalling a Java application

- Select the application in the Applications main view and select **Options**→ *Remove*.

Java application settings

To define a default access point for downloading missing application components, select **Options**→ *Settings*→ *Default access point*. For more information on creating access points, see the '[Access points](#)', p 34.

Select an application and select **Options**→ *Settings*, and then select one of:

- *Access point* - Select an access point to be used by the application for downloading extra data.
- *Network connection* - Some Java applications may require a data connection to be made to a defined access point. If no access point has been selected, you will be asked to select one. The options are:
 - Allowed* - The connection is created immediately without a notification.
 - Ask first* - You will be asked before the application makes the connection.
 - Not allowed* - Connections are not allowed.

15. Manager – installing applications and software

➔ Go to **Menu**→
Tools→ **Manager**



Options in the Manager main view: [View details](#), [View certificate](#), [Install](#), [Remove](#), [View log](#), [Send log](#), [Memory details](#), [Help](#), and [Exit](#).

 **Tip!** To install Java™ applications (file extension .JAD or .JAR), go to Applications. For further information, see [‘Applications \(Java™\)’](#), p. [125](#).

 **Note:** Your phone must be switched on to use the functions in the **Tools** folder. Do not switch the phone on when wireless phone use is prohibited or when it may cause interference or danger.

In Manager you can install new applications and software packages, and remove applications from your phone. You can also check the memory consumption.

When you open Manager, you can see a list of:

- installation packages that have been saved to Manager,
- partially installed applications (indicated by ), and
- fully installed applications that you can remove (indicated by .

 **Note:** In Manager, you can only use device software installation files with an extension .SIS.

- Scroll to an installation file and select **Options**→ [View details](#) to view the *Name*, *Version*, *Type*, *Size*, *Supplier*, and *Status* of the software package.
- Scroll to a software package and select **Options**→ [View certificate](#) to display the security certificate details of a software package. See [‘Certif. management’](#), p. [41](#).

 **Important:** Only install software from sources that offer adequate protection against viruses and other harmful software.

To help you, the software installation system uses digital signatures and certificates on software packages. Do not install the application if Manager gives a security warning during installation.

Installing software

You can install applications that are specifically intended for the Nokia 3660 or suitable for the Symbian operating system. A software package is usually one large compressed file containing many component files.



Note: If you install a program that is not intended specifically for the Nokia 3660, it may function and look very different from the usual Nokia 3660 applications.



Important: If you install a file that contains an update or repair to an existing application, you can only restore the original application if you have the original installation file or a full back-up copy of the removed software package. To restore the original application, first remove the application and then install the application again from the original installation file or the back-up copy.

- 1 Installation packages may be transferred to your phone from a computer, downloaded during browsing, or sent to you in a multimedia message, as an e-mail attachment, via Bluetooth, or via infrared. If you are using PC Suite for Nokia 3660 to transfer the file, place it in the `c:\nokia\installs` folder on your phone.
- 2 Open Manager, scroll to the installation package, and select **Options** → *Install* to start the installation.
Alternatively, search the phone memory or the memory card for the installation file, select the file, and press  to start the installation. See the example on the side of the page.

If you are installing software without a digital signature or a certificate, the phone warns you of the risks of installing software. Continue installation only if you are absolutely sure of the origin and contents of the software package.

During installation, the phone checks the integrity of the package to be installed. The phone shows information about the checks being carried out and you are given options whether to continue or cancel the installation. Once the phone has checked the integrity of the software package, the application is installed on your phone.



Tip! Select **Options** → *View log* to see what software packages have been installed or removed and when.



Example: If you have received the installation file as an e-mail attachment, go to your mailbox, open the e-mail, open the Attachments view, scroll to the installation file, and press  to start the installation.

 **Tip!** To send your installation log to a help desk so that they can see what has been installed or removed, select **Options**→ *Send log*→ *Via text message* or *Via e-mail* (available only if the correct e-mail settings are in place).

Removing software

- 1 To remove a software package, scroll to it and select **Options**→ *Remove*.
- 2 Press **Yes** to confirm the removal.



Important: If you remove software, you can only re-install it if you have the original software package or a full back-up of the removed software package. If you remove a software package, you may no longer be able to open documents created with that software. If another software package depends on the software package that you removed, the other software package may stop working. Refer to the documentation of the installed software package for details.

Viewing memory consumption

- To open the memory view select **Options**→ *Memory details*.



Note: If you have a memory card installed on your phone, you will have a choice of two memory views, one for the phone or *Phone memory* and one for the *Memory card*. If not, you will only have the *Phone memory* view.

When you open either of the memory views, the phone calculates the amount of free memory for storing data and installing new software. In the memory views, you can view the memory consumption of the different data groups: *Calendar*, *Contacts*, *Documents*, *Messages*, *Images*, *Sound files*, *Video clips*, *Applications*, *Mem. in use*, and *Free memory*.



Tip! If the phone memory is getting low, remove some documents, or move them to the memory card. See also the '[Troubleshooting](#)' chapter, p 141.

16. Connectivity

 **Note:** Your phone must be switched on to use the functions in the **Connectivity** folder. Do not switch the phone on when wireless phone use is prohibited or when it may cause interference or danger.

You can transfer data from your phone to another compatible device, for example, a phone or a computer, via Bluetooth or infrared.



Bluetooth connection

 **Note:** The Nokia 3660 phone is designed to be compliant with and to adopt Bluetooth Specification 1.1. However, interoperability between the phone and other products with Bluetooth wireless technology depends also on the profiles and protocols used. For more information on the compatibility between Bluetooth devices, please consult your dealer.

Bluetooth enables cost-free wireless connections between electronic devices within a maximum range of 10 metres. A Bluetooth connection can be used to send images, videos, texts, business cards, calendar notes, or to connect wirelessly to Bluetooth-enabled devices such as computers.

Since Bluetooth devices communicate using radio waves, your phone and the other Bluetooth device do not need to be in direct line-of-sight. See Fig. 1, p. 131.

The two devices only need to be within a maximum of 10 metres of each other, although the connection can be subject to interference from obstructions such as walls or from other electronic devices.

 Go to **Menu** →
Connectivity →
Bluetooth

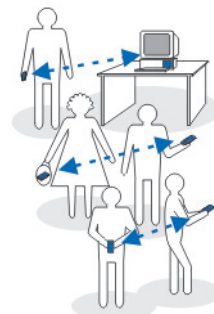

Fig. 1 Using Bluetooth.

Using Bluetooth consumes the battery and the phone's operating time will be reduced. Take this into account when performing other operations with your phone.

There may be restrictions on using Bluetooth devices. Check with your local authorities.

Activating Bluetooth application for the first time

When you activate the Bluetooth application for the first time, you are asked to give a Bluetooth name to your phone.



Note: After you have set Bluetooth to be active and changed *My phone's visibility* to *Shown to all*, your phone and this name can be seen by other Bluetooth device users.

- Write a name (max. 30 letters). If you send data via Bluetooth before you have given an individual Bluetooth name to your phone, the default name will be used.

Bluetooth settings

To modify Bluetooth settings, scroll to the setting you want to change and press .

- *Bluetooth* - Select *On* if you want to use Bluetooth. If you set Bluetooth *Off* all active Bluetooth connections are ended and Bluetooth cannot be used for sending or receiving data.
- *My phone's visibility* - If you select *Shown to all* your phone can be found by other Bluetooth devices during device search. If you select *Hidden* your phone cannot be found by other devices during device search.
- *My Bluetooth name* - Define a Bluetooth name for your phone. After you have set Bluetooth to be active and changed *My phone's visibility* to *Shown to all*, this name can be seen by other Bluetooth device users.

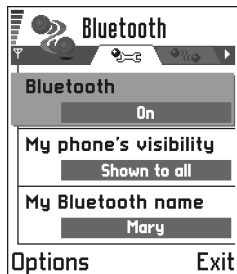





Fig. 2 Bluetooth settings

 **Tip!** When searching for devices, some Bluetooth devices may show only the unique Bluetooth addresses (device addresses). To find out the unique Bluetooth address of your phone, enter the code ***#2820#** in standby mode.

 **Tip!** To send text via Bluetooth (instead of text messages), go to **Notes**, write the text, and select **Options** → **Send** → **via Bluetooth**.

Sending data via Bluetooth

 **Note:** There can be only one active Bluetooth connection at a time.

- 1 Open an application where the item you wish to send is stored. For example, to send a photo to another device, open the Images application.
- 2 Scroll to the item you want to send, for example, a photo and select **Options** → **Send** → **Via Bluetooth**.
- 3 The phone starts to search for devices within range. Bluetooth enabled devices that are within range start to appear on the display one by one. See Fig. 3, p. 133. You can see a device icon, the device's Bluetooth name, the device type, or a short name. Paired devices are shown with .

 **Note:** If you have searched for Bluetooth devices earlier, a list of the devices that were found previously is shown first. To start a new search, select **More devices**. If you switch off the phone, the list of devices is cleared and the device search needs to be started again before sending data.

- To interrupt the search, press **Stop**. The device list freezes and you can start to form a connection to one of the devices already found.



Fig. 3 Sending an image via Bluetooth, the phone starts to search for devices.



Glossary: Pairing means authentication. The users of the Bluetooth-enabled devices should agree together what the passcode is, and use the same passcode for both devices in order to pair them. Devices that do not have a user interface have a factory-set passcode.

Icons for different Bluetooth devices:



- *Computer*,



- *Phone*,



- *Other*, and



- *Unknown*.

- 4 Scroll to the device you want to connect with and press **Select**. The item you are sending is copied to Outbox and the note *Connecting* is shown.
- 5 **Pairing (if not required by the other device, go to step 6)**
 - If the other device requires pairing before data can be transmitted, a tone sounds and you are asked to enter a passcode.
 - Create your own passcode (1-16 characters long, numeric) and agree with the owner of the other Bluetooth device to use the same code. This passcode is used only once and you do not have to memorise it.
 - After pairing, the device is saved to the Paired devices view.
- 6 When the connection has been successfully established, the note *Sending data* is shown.



Note: Data received via Bluetooth can be found in the Inbox folder in Messaging. See p. 81 for further information.



Note: If sending fails, the message or data will be deleted. The Drafts folder in Messaging does not store messages sent via Bluetooth.

Checking the status of the Bluetooth connection

- When is shown in standby mode, Bluetooth is active.
- When is blinking, your phone is trying to connect to the other device.
- When is shown continuously, the Bluetooth connection is active.

Paired devices view

Pairing with a device makes device searches easier and quicker. Paired devices are easier to recognise, they are indicated by in the search result list. In the Bluetooth main view, press to open a list of paired devices ().

Pairing with a device

- 1 Select **Options**→ *New paired device* in the Paired devices view. The phone starts to search for devices within range. Or, if you have searched for Bluetooth devices earlier, a list of the devices that were found previously is shown first. To start a new search, select **More devices**.
- 2 Scroll to the device you want to pair with and press **Select**.
- 3 Exchange passcodes, see step 5 (Pairing) in the previous section. The device is added to the Paired devices list.

Cancelling pairing

- In the Paired devices view, scroll to the device whose pairing you want to cancel and press **C** or select **Options**→ *Delete*. The device is removed from the Paired devices list and the pairing is cancelled.
- If you want to cancel all pairings, select **Options**→ *Delete all*.



Note: If you are currently connected to a device, and delete the pairing with that device, pairing is removed immediately but the connection will remain active.

Assigning short names for paired devices

You can define a short name (nickname, alias), to help you recognise a certain device. This name is stored in the phone memory and cannot be seen by other Bluetooth device users.

- To assign a short name, scroll to the device and select **Options**→ *Assign short name*. Write the short name and press **OK**.



Note: Choose a name which is easy to remember and recognise. Later when you are searching for devices or a device is requesting a connection, the name you have chosen will be used to identify the device.

Options in the paired devices view: *New paired device, Connect / Disconnect, Assign short name, Delete, Delete all, Set as authorised / Set as unauthorised, Help, and Exit.*



Tip! You can also play phone-to-phone games via Bluetooth.



Example: Give a short name to your friend's Bluetooth-enabled device or to your own computer to be able to recognise it more easily.

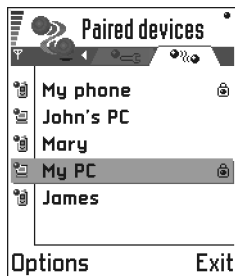



Fig. 4 Two devices are set to be authorised.

Setting a device to be authorised or unauthorised



After you have paired with a device, you can set it to be authorised or unauthorised:

Unauthorised (default) – Connection requests from this device need to be accepted separately every time.

Authorised – Connections between your phone and this device can be made without your knowledge. No separate acceptance or authorisation is needed. Use this status for your own devices, for example, your PC, or devices that belong to someone you trust. The icon  is added next to authorised devices in the Paired devices view. See Fig. 4, p. 136.

- In the Paired devices view, scroll to the device and select **Options** → *Set as authorised* / *Set as unauthorised*.

Receiving data via Bluetooth

When you receive data via Bluetooth, a tone sounds and you are asked if you want to accept the Bluetooth message. If you accept,  is shown and the item is placed in the Inbox folder in Messaging. Bluetooth messages are indicated by . See p. 81 for further information.

Disconnecting Bluetooth

A Bluetooth connection is disconnected automatically after sending or receiving data.

Infrared connection

Via infrared, you can send or receive data such as business cards and calendar notes to and from a compatible phone or data device.

Do not point the IR (infrared) beam at anyone's eye or allow it to interfere with other IR devices. This device is a Class 1 Laser product.

 To start infrared, go to **Menu** → **Connectivity** → **Infrared**

Sending and receiving data via infrared



Note: All items which are received via infrared are placed in the Inbox folder in Messaging. New infrared messages are indicated by . See p. 81 for further information.



- 1 Make sure that the infrared ports of the sending and receiving devices are pointing at each other and that there are no obstructions between the devices. The preferable distance between the two devices is one metre at most. To find the infrared port, see the Keys and parts picture in the Quick start guide.
- 2 The user of the receiving device activates the infrared port.
To activate the infrared port of your phone to receive data via infrared, go to **Menu** → **Connectivity** → **Infrared** and press .
- 3 The user of the sending device selects the desired infrared function to start data transfer.
To send data via infrared, select **Options** → **Send** → *via infrared* in an application.

If data transfer is not started within one minute after the activation of the infrared port, the connection is cancelled and must be started again.



Note: Windows 2000: To be able to use infrared to transfer files between your Nokia 3660 and a compatible computer, go to "Control Panel" and select "Wireless Link". In the "Wireless Link" "File Transfer" tab check the "Allow others" to send files to your computer using infrared.

Checking the status of the infrared connection

- When  blinks, your phone is trying to connect to the other device or a connection has been lost.
- When  is shown continuously, the infrared connection is active and your phone is ready to send and receive data via its infrared port.



Tip! You can also play phone-to-phone games via infrared.



Example: To send a contact card via infrared:
(1) Ask the receiver to activate the infrared port in his/her device. (2) Go to Contacts, scroll to a card and select **Options** → *Send business card* → *via infrared*.

Connecting your phone to a computer

For further information on how to make a connection to a compatible computer via infrared or Bluetooth, and how to install the PC Suite for Nokia 3660, see the **Installation Guide for PC Suite** on the CD-ROM in the 'Install' section. For further information on how to use the PC Suite for Nokia 3660, see the PC suite **online help**.

Using the CD-ROM

The CD-ROM should launch itself after you have inserted it into the CD-ROM drive of your compatible PC. If not, proceed as follows:

- 1 Click the Window **Start** button and select Programs→ Windows Explorer.
- 2 On the CD-ROM drive, locate a file called **Nokia3660.exe** and double-click it. The CD-ROM interface opens.
- 3 You can find PC Suite for Nokia 3660 in the 'Install' section. Double-click 'PC Suite for Nokia 3660'. The installation wizard will guide you through the installation process.



Using your phone as a modem to connect to the Internet or to send or receive faxes

Detailed installation instructions can be found in **Quick guide for Modem Options for Nokia 3660** on the CD-ROM supplied with the phone.



Sync - remote synchronisation



Note: You have to download the Sync application from the Nokia web site www.nokia.com/phones/3660/support.

← Go to **Menu** →
Connectivity → **Sync**

The Sync application enables you to synchronise your calendar or contacts with various calendar and address book applications on a compatible computer or on the Internet. Synchronisation takes place over a GSM data call or packet data connection.

The synchronisation application uses SyncML technology for synchronisation. For information on SyncML compatibility, please contact the supplier of the calendar or address book application you want to synchronise your phone data with.

Creating a new synchronisation profile

- 1 If no profiles have been defined, the phone asks you if you want to create a new profile. Select **Yes**.
To create a new profile in addition to existing ones, select **Options**→ *New sync profile*. Choose whether you want to use the default setting values or copy the values from an existing profile to be used as the basis for the new profile.
- 2 Define the following:
 - Sync profile name* - Write a descriptive name for the profile.
 - Bearer type* / *Host address* / *Port* / *HTTP authentication* - Contact your service provider or system administrator for the correct values.
 - Access point* - Select an access point you want to use for the data connection. For more information, see '[Connection](#)', p. 31.
 - User name* - Your user ID for the synchronisation server. Contact your service provider or system administrator for your correct ID.
 - Password* - Write your password. Contact your service provider or system administrator for the correct value.
 - Calendar* - Select **Yes** if you want to synchronise your calendar.
 - Remote calendar* - Enter a correct path to the remote calendar on the server. Must be defined if the previous setting *Calendar* has been set to **Yes**.
 - Contacts* - Select **Yes** if you want to synchronise your contacts.



Glossary:

Synchronisation profile is the settings for the remote server. You can create several profiles if you need to synchronise your data with multiple servers or applications.

Options in Remote sync main view: *Synchronise*, *New sync profile*, *Edit sync profile*, *Delete*, *View log*, *Help*, and *Exit*.

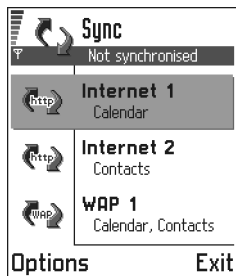



Fig. 5 The Remote synchronisation main view.

Remote contacts - Enter a correct path to the remote address book on the server. It must be defined if the previous setting *Contacts* has been set to *Yes*.

- 3 Press **Done** to save the settings.

Synchronising data

In the Sync main view, you can see the different profiles. See Fig. 5, p. 140. You can also see which protocol the profile uses:  http or  WAP and what kind of data will be synchronised: Calendar, Contacts, or both.

- 1 In the main view, scroll to a profile and select **Options**→ *Synchronise*. The status of the synchronisation is shown at the bottom of the screen.
To cancel synchronisation before it is finished, press **Cancel**.
- 2 You are notified when the synchronisation has been completed.
 - After synchronisation is complete, press **View log** or select **Options**→ *View log* to open a log file showing the synchronisation status (*Complete* or *Incomplete*) and how many calendar or contact entries have been added, updated, deleted, or discarded (not synchronised) in the phone or on the server.

17. Troubleshooting

Memory low

When the following notes are shown, the phone memory is low and you must start to delete some data: *Not enough memory to perform operation. Delete some data first.* or *Memory low. Delete some data.* To view what kind of data you have and how much memory the different data groups consume, go to **Manager** and select **Options**→*Memory details*.

You may want to delete the following items regularly to avoid memory getting low:

- messages from the Inbox, Drafts, and Sent folders in Messaging,
- retrieved e-mail messages from the phone memory,
- saved browser pages, and
- images and photos in Images.

If you want to delete contact information, calendar notes, call timers, call cost timers, game scores, or any other data, go to the respective application to remove the data.

If you are deleting multiple items and another of the following notes are shown: *Not enough memory to perform operation. Delete some data first.* or *Memory low. Delete some data.*, try deleting items one by one (starting from the smallest item).

Clearing calendar memory - To remove more than one event at a time, go to the Month view and select **Options**→ *Delete entry*→ and either

- *Before date* - to delete all calendar notes which take place before a certain date. Enter the date before which all calendar notes will be deleted, or
- *All entries* - to delete all calendar notes.

Erasing log information - To erase all the log contents, Recent calls register, and Messaging delivery reports permanently, go to Logs and select **Options**→ *Clear log* or go to *Settings*→ *Log duration*→ *No log*.

Different ways to store data:

- use PC Suite for Nokia 3660 to take a backup copy of all data to your computer, see p. [138](#),
- send images to your e-mail address and then save the images to your computer, or
- send data via infrared or Bluetooth to another device.

Q&A

Phone display

- Q: Why do missing, discoloured, or bright dots appear on the screen every time I turn on my phone?
A: This is an intrinsic characteristic of the active matrix display. Your phone's display contains multiple switching elements to control the pixels. A small number of missing, discoloured, or bright dots on the screen might exist.

Camera

- Q: Why does the image appear dark when I am taking a picture with the Camera app or viewing images?
A: The display contrast setting affects the appearance of images. Check the display contrast setting and adjust it to lighter. Go to **Settings**→*Phone settings*→*Display*→*Contrast*.
- Q: Why do images look smudgy?
A: Check that the camera lens protection window is clean. To clean the window follow the instructions in ['Care and maintenance'](#), p. 146.

Bluetooth

- Q: Why can't I end a Bluetooth connection?
A: If another device is pairing with your phone but not sending data, and leaves the device connection open, then the only way to disconnect it is to deactivate the Bluetooth link altogether. Go to Bluetooth and select the setting *Bluetooth*→*Off*.
- Q: Why can't I find my friend's Bluetooth-enabled device.

A: Check that both have activated Bluetooth.

Check that the distance between the two devices is not over 10 metres or that there are no walls or other obstructions between the devices.

Check that the other device is not in 'Hidden' mode.

Multimedia messaging

- Q: What should I do when the phone tells me that it cannot receive a multimedia message because memory is full?
A: The amount of memory needed is indicated in the error message: *Not enough memory to retrieve message. Delete some data first*. To view what kind of data you have and how much memory the different data groups consume, go to **Manager** and select **Options**→*Memory details*. After you have freed up memory, the multimedia message centre tries to send the multimedia messages again automatically.
- Q: What should I do when the phone gives the message: *Unable to retrieve multimedia message. Network connection already in use.?*
A: End all active data connections. Multimedia messages cannot be received if another data connection using a different gateway address is active for browser or e-mail.
- Q: How can I end the data connection when the phone starts a data connection again and again? The notes: *Retrieving message* or *Trying to retrieve message again* are shown briefly. What is happening?

A: The phone is trying to retrieve a multimedia message from the multimedia messaging centre.

Check that the settings for multimedia messaging have been defined correctly and that there are no mistakes in phone numbers or addresses. Go to **Messaging** and select **Options** → **Settings** → **Multimedia message**.

To stop the phone from making a data connection, you have the following options. Go to **Messaging** and select **Options** → **Settings** → **Multimedia message**, and then:

- Select **On receiving msg.** → **Defer retrieval** if you want the multimedia messaging centre to save the message to be retrieved later, for example, after you have checked the settings. After this change, the phone still needs to send information notes to the network. To retrieve the message later, select **Retr. immediately**.
- Select **On receiving msg.** → **Reject message** - if you want to reject all incoming multimedia messages. After this change, the phone needs to send information notes to the network and the multimedia messaging centre will delete all multimedia messages that are waiting to be sent to you.
- Select **Multimedia reception** → **Off** - if you want to ignore all incoming multimedia messages. After this change the phone will not make any network connections related to multimedia messaging.

Images

- Q: Is the format of the image I'm trying to open supported?
A: See p. [59](#) for further information on the supported image formats.

Messaging

- Q: Why can't I select a contact?
A: If you cannot select a contact in the Contacts directory, the contact card does not have a phone number or an e-mail address. Add the missing information to the contact card in the Contacts application.

Calendar

- Q: Why are the week numbers missing?
A: If you have changed the Calendar settings so that the week starts on a day other than Monday, then the week numbers will not be shown.

Browser Services

- Q: *No valid access point defined. Define one in Services settings.*
A: Insert proper browser settings. Contact your service provider for instructions. See '[Setting up the phone for the browser service](#)', p. [118](#).

Log

- Q: Why does the log appear empty?
A: You may have activated a filter, and no communication events fitting that filter have been logged. To see all events, select **Options** → **Filter** → **All communication**.

PC connectivity

- Q: Why do I have problems in connecting the phone to my PC?
A: Make sure that PC Suite for Nokia 3660 is installed and running on your PC. See the Installation guide for PC Suite on the CD-ROM in the 'Install' section. For further



information on how to use the PC Suite for Nokia 3660, see the PC suite **online help**.

Access codes

- Q: What is my password for the lock, PIN, or PUK codes?
A: The default lock code is **12345**. If you forget or lose the lock code, contact your phone dealer.
If you forget or lose a PIN or PUK code, or if you have not received such a code, contact your network service provider.

For information about passwords, contact your access point provider, for example, a commercial Internet service provider (ISP), service provider, or network operator.

Application not responding

- Q: How do I close an application that is not responding?
A: Open the application switching window by pressing and holding . Then scroll to the application, and press  to close the application.

18. Battery information

Charging and Discharging

- Your phone is powered by a rechargeable battery.
 - Note that a new battery's full performance is achieved only after two or three complete charge and discharge cycles!
 - The battery can be charged and discharged hundreds of times but it will eventually wear out. When the operating time (talk-time and standby time) is noticeably shorter than normal, it is time to buy a new battery.
 - Use only batteries approved by the phone manufacturer and recharge your battery only with the chargers approved by the manufacturer. Unplug the charger when not in use. Do not leave the battery connected to a charger for longer than a week, since overcharging may shorten its lifetime. If left unused a fully charged battery will discharge itself over time.
 - Temperature extremes can affect the ability of your battery to charge.
 - Use the battery only for its intended purpose.
 - Never use any charger or battery that is damaged.
- Do not short-circuit the battery. Accidental short-circuiting can occur when a metallic object (coin, clip or pen) causes direct connection of the + and - terminals of the battery (metal strips on the battery) for example when you carry a spare battery in your pocket or purse. Short-circuiting the terminals may damage the battery or the connecting object.
 - Leaving the battery in hot or cold places, such as in a closed car in summer or winter conditions, will reduce the capacity and lifetime of the battery. Always try to keep the battery between 15°C and 25°C (59°F and 77°F). A phone with a hot or cold battery may temporarily not work, even when the battery is fully charged. Battery's performance is particularly limited in temperatures well below freezing.
 - Do not dispose of batteries in a fire!
 - Dispose of batteries according to local regulations (e.g. recycling). Do not dispose of as household waste.
 - Remove the battery only when the phone is switched off.

19. Care and maintenance

Your phone is a product of superior design and craftsmanship and should be treated with care. The suggestions below will help you to fulfil any warranty obligations and to enjoy this product for many years.

- Keep the phone and all its parts and accessories out of the reach of small children.
 - Keep the phone dry. Precipitation, humidity and all types of liquids or moisture can contain minerals that will corrode electronic circuits.
 - Do not use or store the phone in dusty, dirty areas. Its moving parts can be damaged.
 - Do not store the phone in hot areas. High temperatures can shorten the life of electronic devices, damage batteries, and warp or melt certain plastics.
 - Do not store the phone in cold areas. When it warms up (to its normal temperature), moisture can form inside, which may damage electronic circuit boards.
- Do not attempt to open the phone. Non-expert handling may damage it.
 - Do not drop, knock or shake the phone. Rough handling can break internal circuit boards.
 - Do not use harsh chemicals, cleaning solvents, or strong detergents to clean the phone.
 - Do not paint the phone. Paint can clog the moving parts and prevent proper operation.
 - Use a soft, clean and dry cloth to clean the camera lens.
 - Use only the supplied or an approved replacement antenna. Unauthorised antennas, modifications or attachments could damage the phone and may violate regulations governing radio devices.

All of the above suggestions apply equally to your phone, battery, charger or any accessory. If any of them are not working properly, take it to your nearest qualified service facility. The personnel there will assist you and, if necessary, arrange for service.

20. Important safety information

Traffic Safety

Do not use a hand-held telephone while driving a vehicle. Always secure the phone in its holder; do not place the phone on the passenger seat or where it can break loose in a collision or sudden stop.

Remember road safety always comes first!

Operating environment

Remember to follow any special regulations in force in any area and always switch off your phone whenever it is forbidden to use it, or when it may cause interference or danger.

Use the phone only in its normal operating positions.

To maintain compliance with RF exposure guidelines only use Nokia approved accessories. When the phone is on and being worn on the body, always use a Nokia approved carrying case.

Parts of the phone are magnetic. Metallic materials may be attracted to the phone, and persons with a hearing aid should not hold the phone to the ear with the hearing aid. Always secure the phone in its holder, because metallic materials may be attracted by the earpiece. Do not place credit cards or other magnetic storage media near the phone, because information stored on them may be erased.

Electronic devices

Most modern electronic equipment is shielded from radio frequency (RF) signals. However, certain electronic equipment may not be shielded against the RF signals from your wireless phone.

Pacemakers Pacemaker manufacturers recommend that a minimum separation of 20 cm (6 inches) be maintained between a handheld wireless phone and a pacemaker to avoid potential interference with the pacemaker. These recommendations are consistent with the independent research by and recommendations of Wireless Technology Research. Persons with pacemakers:

- Should always keep the phone more than 20 cm (6 inches) from their pacemaker when the phone is switched on;
- Should not carry the phone in a breast pocket;
- Should use the ear opposite the pacemaker to minimise the potential for interference.
- If you have any reason to suspect that interference is taking place, switch off your phone immediately.

Hearing aids Some digital wireless phones may interfere with some hearing aids. In the event of such interference, you may want to consult your service provider.

Other medical devices Operation of any radio transmitting equipment, including cellular phones, may interfere with the functionality of inadequately protected medical devices. Consult a physician or the manufacturer of the medical

device to determine if they are adequately shielded from external RF energy or if you have any questions. Switch off your phone in health care facilities when any regulations posted in these areas instruct you to do so. Hospitals or health care facilities may be using equipment that could be sensitive to external RF energy.

Vehicles RF signals may affect improperly installed or inadequately shielded electronic systems in motor vehicles (e.g. electronic fuel injection systems, electronic anti-skid (anti-lock) braking systems, electronic speed control systems, air bag systems). Check with the manufacturer or its representative regarding your vehicle. You should also consult the manufacturer of any equipment that has been added to your vehicle.

Posted facilities Switch your phone off in any facility where posted notices so require.

Potentially explosive atmospheres

Switch off your phone when in any area with a potentially explosive atmosphere and obey all signs and instructions. Sparks in such areas could cause an explosion or fire resulting in bodily injury or even death.

Users are advised to switch off the phone when at a refuelling point (service station). Users are reminded of the need to observe restrictions on the use of radio equipment in fuel depots (fuel storage and distribution areas), chemical plants or where blasting operations are in progress.

Areas with a potentially explosive atmosphere are often but not always clearly marked. They include below deck on boats; chemical transfer or storage facilities; vehicles using

liquified petroleum gas (such as propane or butane); areas where the air contains chemicals or particles, such as grain, dust or metal powders; and any other area where you would normally be advised to turn off your vehicle engine.

Vehicles

Only qualified personnel should service the phone, or install the phone in a vehicle. Faulty installation or service may be dangerous and may invalidate any warranty which may apply to the unit.

Check regularly that all wireless phone equipment in your vehicle is mounted and operating properly.

Do not store or carry flammable liquids, gases or explosive materials in the same compartment as the phone, its parts or accessories.

For vehicles equipped with an air bag, remember that an air bag inflates with great force. Do not place objects, including both installed or portable wireless equipment in the area over the air bag or in the air bag deployment area. If in-vehicle wireless equipment is improperly installed and the air bag inflates, serious injury could result.

Using your phone while in the air is prohibited. Switch off your phone before boarding an aircraft. The use of wireless telephones in an aircraft may be dangerous to the operation of the aircraft, disrupt the wireless telephone network and may be illegal.

Failure to observe these instructions may lead to suspension or denial of telephone services to the offender, or legal action or both.



Emergency calls



Important: This phone, like any wireless phone, operates using radio signals, wireless and landline networks as well as user-programmed functions. Because of this, connections in all conditions can not be guaranteed. Therefore you should never rely solely upon any wireless phone for essential communications (e.g. medical emergencies).

Emergency calls may not be possible on all wireless phone networks or when certain network services and/or phone features are in use. Check with local service providers.

To make an emergency call:

- 1 If the phone is not on, switch it on. Check for adequate signal strength.
Some networks may require that a valid SIM card is properly inserted in the phone.
- 2 Press  as many times as needed (e.g. to exit a call, to exit a menu, etc.) to clear the display and ready the phone for calls.
- 3 Key in the emergency number for your present location (e.g. 112 or other official emergency number). Emergency numbers vary by location.
- 4 Press the  key.

If certain features are in use, you may first need to turn those features off before you can make an emergency call. Consult this guide and your local cellular service provider.

When making an emergency call, remember to give all the necessary information as accurately as possible. Remember that your wireless phone may be the only means of

communication at the scene of an accident – do not cut off the call until given permission to do so.

Certification information (SAR)

THIS MODEL PHONE MEETS THE EU REQUIREMENTS FOR EXPOSURE TO RADIO WAVES.

Your mobile phone is a radio transmitter and receiver. It is designed and manufactured not to exceed the limits for exposure to radio frequency (RF) energy recommended by The Council of the European Union. These limits are part of comprehensive guidelines and establish permitted levels of RF energy for the general population. The guidelines were developed by independent scientific organisations through periodic and thorough evaluation of scientific studies. The limits include a substantial safety margin designed to assure the safety of all persons, regardless of age and health.

The exposure standard for mobile phones employs a unit of measurement known as the Specific Absorption Rate, or SAR. The SAR limit recommended by The Council of the European Union is 2.0 W/kg.* Tests for SAR have been conducted using standard operating positions with the phone transmitting at its highest certified power level in all tested frequency bands. Although the SAR is determined at the highest certified power level, the actual SAR level of the phone while operating can be well below the maximum value. This is because the phone is designed to operate at multiple power levels so as to use only the power required to reach the network. In general, the closer you are to a base station antenna, the lower the power output.

Before a phone model is available for sale to the public, compliance with the European R&TTE directive must be

shown. This directive includes as one essential requirement the protection of the health and the safety for the user and any other person. The highest SAR value for this model phone when tested for compliance against the standard was 0.75 W/kg. While there may be differences between the SAR levels of various phones and at various positions, they all meet the EU requirements for RF exposure.

This product meets RF exposure guidelines when used either in the normal use position against the ear or when positioned at least 1.5 cm away from the body. When a carry case, belt clip or holder is used for body-worn operation, it

should not contain metal and should position the product at least 1.5 cm away from your body.

* The SAR limit for mobile phones used by the public is 2.0 watts/kilogram (W/kg) averaged over ten grams of tissue. The limit incorporates a substantial margin of safety to give additional protection for the public and to account for any variations in measurements. SAR values may vary depending on national reporting requirements and the network band. For SAR information in other regions please look under product information at www.nokia.com.

Index

A

- Access codes 38
- Access points 31
 - Settings 34
 - Settings, Advanced 36
- Access points, glossary explanation 31
- Accessories
 - Settings 44
- Activating loudspeaker 15
- Alarm clock 112
 - Snooze 112
- Animations 58
- Answering a call 19
 - Automatic 44
- Applications 125
 - Installing a Java application 126
 - Java application settings 127
 - Opening a Java application 127
 - Uninstalling a Java application 127
- Attachments
 - Retrieving 89
 - Viewing 89
- Audio files
 - See *Media files*
- Automatic answer 44

B

- Background image

See *Settings, General*

- Barring calls 43
- Battery information 145
- Bluetooth 131
 - Cancelling pairing 135
 - Connection requests 134
 - Connection status indicators 134
 - Device icons 134
 - Disconnecting 136
 - Factory-set passcode 134
 - Pairing 134
 - Pairing requests 134
 - Passcode, glossary explanation 134
 - Receiving data 136
 - Sending data 133
 - Settings 132
 - Short names for paired devices 135
 - Unique device address 133

Bookmark, glossary explanation 119

Browser

- Browser access points, see *Access points*
- Connecting 118
- Ending connections 123
- Icons 119
- WAP pages 117

XHTML pages 117

- Browsing 120
- Buffering
 - Glossary explanation 66
- Business card, glossary explanation 51
 - Sending 51

C

- Cache, glossary explanation 122
- Calculator 108
- Calendar 102
 - Alarm 105
 - Calendar entry fields 103
 - Data Import 107
 - Deleting many entries
 - simultaneously 141
 - Remote synchronisation 139
 - Sending entries 105
 - Settings 105
 - Stopping alarms 105
 - Symbols 104
 - Views 104

Call barring 43

Call cost limit

- Resetting the counter 24
- Set by a service provider 24

Call register

See *Log*

Calling 17

With a voice tag 49

Calls

Answering 19

Charging units 24

Conference calls 18

Cost limit 24

Dialled 22

Diverting 19

Duration 23

International 17

Missed 22

Options during a call 20

Received 22

Rejecting 19

Settings 29

Settings for diverting 21

Speed dialling 18

Transferring 20

Using the Contacts directory 17

Camera 53

Image types 55

Memory card 56

Memory consumption 56

Settings 54

CD-ROM 138

Cell broadcast messages 91

Cell info display 44

Certificates 41

Trust settings 42

Charges

Packet data 33

Clearing memory

Calendar entries 141

Log information 141

Clip

See *Video recorder*

Clock 112

Alarm 112

Settings 112

Composer 109

Adjusting sound volume 109

Adjusting tempo 109

Changing tone style 109

Listening to tones 109

Computer connections 138

Conference calls 18

Connection indicators

Bluetooth 134

Data connections 10

Infrared 137

Connection settings 31

Contact cards

Adding voice tags 48

Assigning default numbers and addresses 47

Assigning speed dialling numbers 49

Attaching ringing tones 50

Changing voice tags 49

Deleting voice tags 49

Inserting pictures 46

Listening to voice tags 49

Remote synchronisation 139

Removing ringing tones 50

Storing DTMF tones 21

Voice tags 48

Contact groups 51

Adding many members at the same time 52

Adding ringing tones 50

Removing members 52

Contacts

Data Import 52

Converter 110

Adding exchange rates 111

Converting currencies 111

Converting units 110

Renaming currencies 111

Copying

Contacts between the SIM card and phone memory 45

Text 73

Creating

Contact cards 45

Cutting

Text 74

D

Data connections

Indicators 10

- Settings 31
- Data Import
 - Calendar and To-do 107
 - Contacts 52
- Date, settings 38
- Deleting
 - Calendar entries 103
 - Contact cards 46
- Delivery reports 69
- Dialled numbers 22
- Digital rights management 123
- Disconnecting
 - Bluetooth 136
- Display settings 29
- Diverting calls 19
- DNS, Domain Name Service, glossary explanation 36
- DRM 123
- DTMF tones, glossary explanation 20
- E**
- Editing
 - Calendar entries 102
 - Contact cards 46
 - Text 71
- E-mail 80
 - Attachments 89
 - Deleting 90
 - Offline 87
 - Online 86
 - Opening 88

- Remote mailbox 85
- Retrieving from mailbox 87
- Saving attachments 89
- Settings 96
- Emergency calls 149
- Erasing
 - Call cost counters 25
 - Log 25
 - Recent calls register 22
- F**
- Favourites 101
 - Adding a shortcut 101
- File formats
 - JAD and JAR 128
 - RealOne Player 63
 - SIS file 128
 - Supported 89
- Fixed dialling 40
- Folders, creating, organising items to folders 14
- G**
- Games 113
- General settings 27
- GIF animations 58
- GPRS
 - See *Packet data*
- H**
- Handsfree
 - See *Loudspeaker*

- Headset 15
- High speed data, glossary explanation 32
- HSCSD
 - See *High speed data*
- I**
- Idle state
 - See *Standby mode*
- Image modes 55
- Images 57
 - Adding to a contact card 46
 - Formats 59
 - Full screen 58
 - Keyboard shortcuts when viewing images 59
 - Memory consumption 56
 - Moving the focus 58
 - Organising 59
 - Picture messages folder 60
 - Receiving from a digital camera 57
 - Rotating 58
 - Viewing image details 59
 - Zooming 58
- Importing data from other Nokia phones 52, 107
- Indicators 9
 - Data connections 10
- Info service 91
- Infrared 136
- Installing software 129

Internet access points (IAP)

See *Access points*

IP address, glossary explanation 36

ISDN, glossary explanation 36

ISP

See *Internet service provider*

J

JAD and JAR files 128

Java

See *Applications*.

JPEG, glossary explanation 53

L

Language

for writing 28

Limit for call costs 24

Listening to messages 18

Lock code 39

Log

Erasing contents 25

Filtering 25

Recent calls 22

Settings 26

Loopset

Activating 44

Loudspeaker 15

Activating 15

Turning off 15

M

Mailbox 85

Disconnecting 88

Making calls 17

Media files

File formats 63

Glossary explanation 63

Playing 64

Memory card 114

Backup 115

Camera 56

Consumption 116

Format 115

Password 116

Restore 115

Unlock 116

Video clips 114

Memory low

Troubleshooting 141

Viewing memory consumption
116, 130

Menu 10

Menu key 10

Rearranging the main Menu 11

Messaging

Delivery reports 69

Inbox 81

Main view 68

Messages on the SIM card 91

Multimedia messages 76

My folders 85

Outbox 91

Picture messages 76

Saving picture message graphics
60

Sent folder settings 98

Settings 92

Text messages 75

Writing e-mail 80

Writing text 71

Missed calls 22

Modem

Using your phone as a modem 138

Multimedia messages 76

Creating 78

Playing sounds 83

Viewing 82

Music files

See *Media files*

My folders 85

N

Notes 112

O

Offline 87

Online 86

Online help 12

Organising

Menu 11

Outbox 91

P

Packet data 32

- Connection timer 26
- Data counter 26
- Glossary explanation 32
- Pricing 33
- Settings 37
- Pairing, glossary explanation 134
- Password
 - Memory card 116
- Pasting
 - Text 74
- PC
 - Connecting 138
- PC Suite for Nokia 3660 138
- Phonebook
 - See *Contacts*
- Pictures
 - Taking 53
 - Viewing 57
- PIN code 38
 - Unlocking 39
- Playing video 62, 64
- Predictive text input 71
 - Tips 72
 - Turning off 73
- Prices for packet data 33
- Profiles 99
 - Renaming 100
 - Settings 99
- R**
- RealOne Player 63

- File formats 63
- Media guide 64
- Streaming 65
- Volume control 66
- Received calls 22
- Receiving
 - Data via Bluetooth 136
 - Data via infrared 137
 - Ringling tones, Operator logos, and settings, see Smart messages*
- Recent calls register 22
 - Call charging units 24
 - Call cost limit 24
 - Call costs 23
 - Call duration 23
 - Dialled numbers 22
 - Erasing call lists 22
 - Missed calls 22
 - Received calls 22
- Recorder, recording sounds 113
- Recording video 61
- Recording voice tags 48
- Rejecting calls 19
- Remote mailbox 85
 - Disconnecting 88
- Remote synchronisation 138
- Removing software 130
- Reports 69
- Resolution, glossary explanation 55
- Ringling tones 99

- Adding a personal ringling tone 50
- Muting 19
- Receiving in a smart message 83
- Settings 99
- S**
- Safety information
 - Care and maintenance 146
 - Electronic devices 147
 - Emergency calls 149
 - Operating environment 147
 - Potentially explosive atmospheres 148
 - Traffic safety 147
 - Vehicles 148
- Screen saver
 - Settings 29
- Search field 14
- Security
 - Access codes 38
 - Security certificates 41
 - Settings 38
- Sending
 - Calendar entries 105
 - Contact cards, Business cards 51
 - Data via Bluetooth 133
 - Data via infrared 137
 - Media files 66
 - Video clips 62, 66
- Service command editor 92
- Service message

- Settings 97
- Service messages 84
- Service provider for data connections,
glossary explanation 31
- Settings 27
 - Access codes 38
 - Accessories 44
 - Applications (Java™) 127
 - Bluetooth 132
 - Calendar 105
 - Call barring 43
 - Call diverting 21
 - Camera 54
 - Certificates 41
 - Clock 112
 - Connection 31
 - Date and time 38
 - Device settings 27
 - Display 29
 - E-mail 96
 - Fixed dialling 40
 - General 27
 - Info service 98
 - Lock code 39
 - Log 26
 - Messaging 92
 - Messaging, Sent folder 98
 - PIN code 38
 - RealOne Player 67
 - Security 38

- Service messages 97
- Sounds 99
- Text messages 93
- Video recorder 62
- Shared memory 16
- Shortcuts
 - in Favourites 101
 - in Images 59
- SIM card
 - Copying names and numbers 45
 - Messages 91
 - Names and numbers 26
 - Viewing messages on SIM 26
- SIS file 128
- Smart messages
 - Receiving 83
 - Sending 75
- Snooze 112
- Software
 - Installing 129
 - Removing 130
 - Transferring a .SIS file to your
phone 129
- Sound files
 - See *Media files*
- Sounds 99
 - Removing a personal ringing tone
50
- Speed dialling 49
 - Making calls 18

- Standby mode 8
 - Indicators 9
 - Settings 28
- Stopping
 - Alarm clock 112
 - Calendar alarm 105
- Streaming
 - Glossary explanation 65
- Switching between applications 12
- Symbols for
 - Calendar entries 104
- Synchronisation
 - See *Remote synchronisation*.
- SyncML
 - See *Remote synchronisation*.
- T**
- Taking pictures 53
- Text input 71
- Text message service centre
 - Adding new 93
- Text messages 75
 - Writing and sending 75
- Text templates 85
- Thumbnails
 - In a contact card 46
- Time, settings 38
- To-do 106
 - Data Import 107
- Tones 99
- Tools

See *Manager - installing applications and software* chapter

[Traditional text input](#) 71

[Transferring calls](#) 20

[Troubleshooting](#) 141

U

[Unit converter](#) 110

[USSD commands](#) 92

V

[vCard format](#) 51

[Video clips](#)
See *Media files*

[Video player](#)
See *RealOne Player*

[Video recorder](#) 61

- Memory card 62
- Saving video clips 62
- Sending video clips 62
- Settings 62
- Video clips 62

[Viewing](#)

- GIF animations 58
- Images 57

[Voice dialling](#) 48

[Voice mailbox](#) 18

- Changing the number 18
- Diverting calls to voice mailbox 21

[Voice messages](#) 18

[Voice recorder](#) 113

[Voice tags](#) 48

- Adding 48
- Changing 49
- Deleting 49
- Glossary explanation 45
- Listening 49
- Making calls 49

[Volume control](#) 14

- During a call 17

W

[WAP pages](#)

- Browser 117

[Writing](#) 71

- Predictive text input 71
- Predictive text input, turning off 73
- Traditional text input 71

X

[XHTML browser](#) 117

[XHTML glossary explanation](#) 117

[XHTML pages](#)

- Browser 117

Z

[Zooming](#) 58